

PLL-FM MODULATOR SUITABLE FOR MOBILE AND RADIO COMMUNICATION SIMULATION

DONE BY ENG. AMR ABDELREHIM YOUSSEF, SUPERVISED BY PROFESSEUR DR.MOHAMED ABOU ELELA, AIN SHAMS UNIVERSITY, FACULTY OF ENGINEERING, CAIRO.

ABSTRACT

This paper shows a new PLL-FM Modulator with rapid acquisition time about 1000 times less than the conventional PLL with less spurs which is suitable in Mobile and Radio communication.

One of the great advantages of the proposed PLL is that it doesn't need LPF(since no spurs coming form the Phase Detector) thus good frequency switching speed and no degradation in transients. The proposed PLL here uses a new technique where the phase detector here acts as a subtractor not between the Ref. Signal and the V.C.O output but between their linear phase time function sawtooth.

1. INTRODUCTION

In radio & mobile communication high speed frequency synthesizer used has to have fast carrier-frequency acquisition speed & lower cutoff modulation frequency.

For high speed frequency synthesizer there are two types, one is the digital frequency synthesizer (DDS) where the switching speed is high but spurs appear is difficult to reject them, also DDS needs high power consumption.

The second type are PLL-synthesizers which are less power consumption & easily implemented in small communication equipment.

One of the main problems of this type of PLL-FM modulators that a low pass filter (LPF) is required to suppress the spurs coming from the phase detector but at the same time the LPF decreases the frequency switching speed thus causes degradation of the transients.

One of the advantages of the proposed PLL-synthesizer in this paper that it doesn't need a LPF where no spurs are generated from the phase detector. The phase detector proposed here is no more than a subtractor between the reference phase & feedback phase coming from the V.C.O.

2. PLL BASIC BLOCK

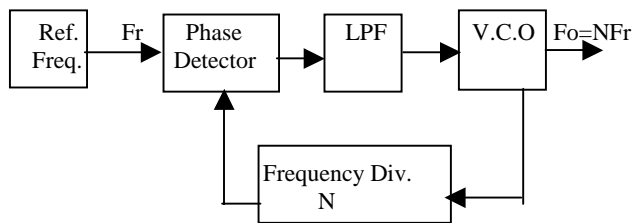

Figure 1

Figure1 shows the PLL basic block describes the normal PLL-synthesizer where the Reference Frequency F_r is applied to one

input of the phase detector & the output of the V.C.O which has a central frequency $F_o=NFr$ is applied to a frequency divider (N) & the output of the frequency divider is applied to the other input of the phase detector.

The phase detector generates a phase error where the LPF takes the average signal & adjust it to be suitable applied to the V.C.O which notices the phase error thus increasing or decreasing its output frequency.

The Process is repeated several time until the locking is done where the output frequency of the V.C.O is NFr and synchronized with the input reference frequency F_r . Here the LPF with $K(lpf)=(K_pK_lK_v.c.o)/N$, where $K(lpf), K_p, K_l, K_v.c.o$, represents the gains of LPF, Phase detector, Loop gain & Voltage control oscillator, causes degradation in the loop transient time which is not useful in case of mobile communication.

That means for the normal PLL-synthesizer for any small change in N division factor needs a higher locking time which becomes useless in some applications specially in mobile communications.

In the next section, a proposed PLL-synthesizer which doesn't need a LPF will overcome this problem.

3. PLL-FM with fast acquisition time.

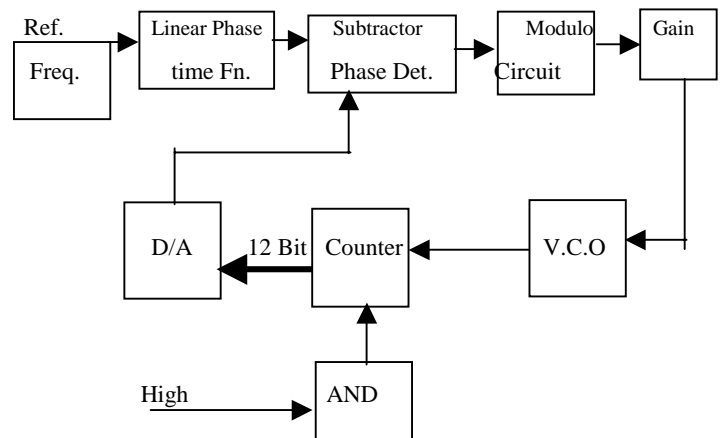

Figure 2

4. Simulation Results

4.1 General Parameters

Reference Sawtooth signal

- 10 V amplitude
- 5MHz freq. representing 50MHz Sinusoidal Input Signal
- Phase=0 degree.

V.C.O

- Sinusoidal with amplitude 5V, $F_o=50\text{MHz}$
- Sensitivity 3.5MHz/V

DAC

- 12 Bit, Threshold=0.5V

Counter

- 12 Bit, Threshold=0.5V

Modulo Circuit Value = 10

Gain=3

4.2 Input Signal Frequency & Phase variation.

4.2.1

Reference sawtooth signal

- 10 V amplitude
- 5.1MHz freq. representing 51MHz Sinusoidal Input Signal
- Phase=0 degree.



Figure 5

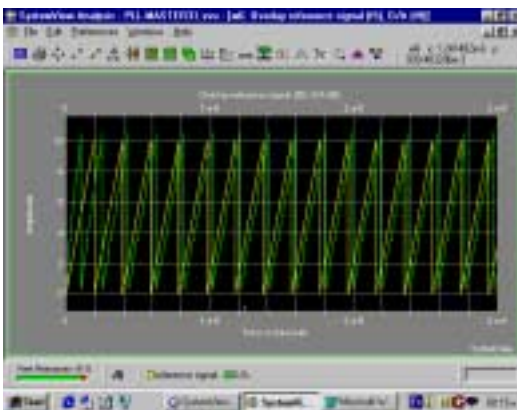

4.2.2

Reference Sawtooth signal

- 10 V amplitude
- 5.1MHz freq. representing 51MHz Sinusoidal Input Signal
- Phase=90 degree.

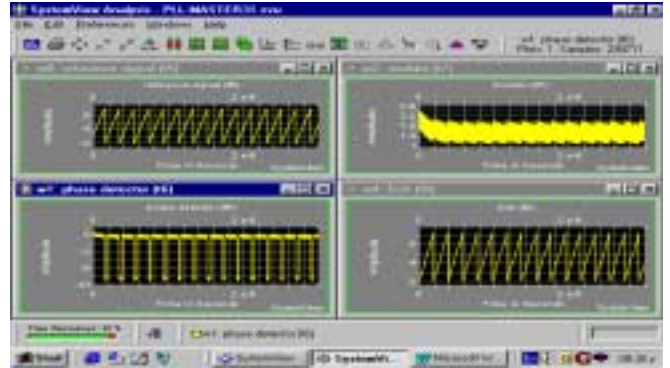
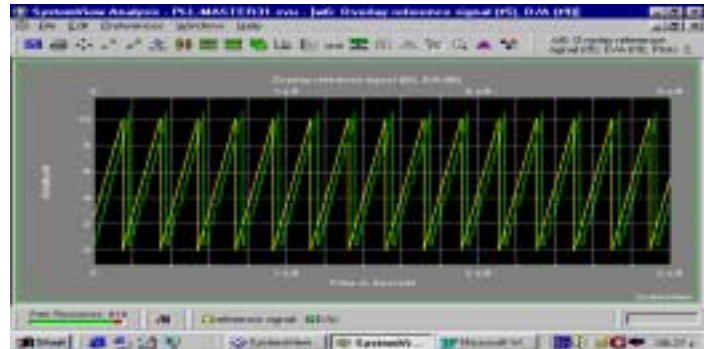

Figure6



4.2.3

Reference Sawtooth signal

- 10 V amplitude
- 5.4MHz freq. representing 54MHz Sinusoidal Input Signal
- Phase=90 degree.

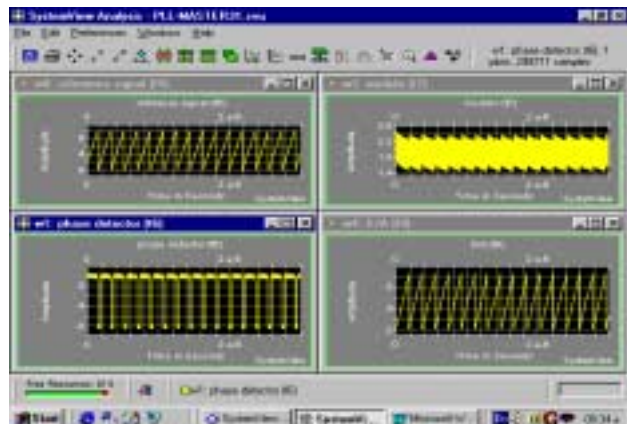
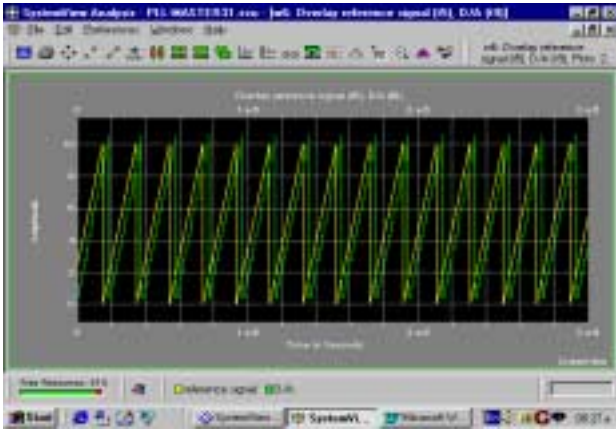

Figure 7



5. Simulation Conclusion

As shown from the above figures when we change the frequency of the input sawtooth from the 5 to 5.1 MHz (means ref. Freq. of $10V \cdot 5.1MHz = 51MHz$ with phase error = 0 degree) the locking is realized so rapidly as figure 5 & when we change the phase i/pt of sawtooth to be 90 degree with the same frequency still locking happens rapidly as figure 6 . Also even if the reference Freq. reached $10V \cdot 5.4MHz = 54MHz$ reference sine signal still we have rapid locking as figure 7.

That means for any higher change in frequency or phase of the input reference signal still locking happens so rapidly.

Also shown less number of spurs at the phase detector output which make the PLL doesn't need any Low Pass Filter.

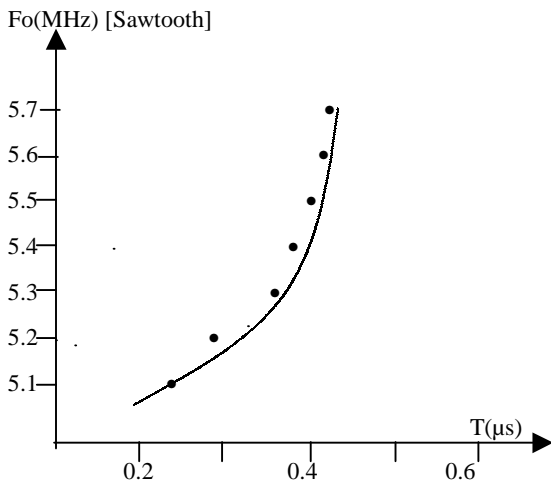

Figure 8

The above Figure 8 shows the relationship between the change of step frequency 1Mhz for the reference frequency and the settling time which is in the range of $0.2\mu s$ for locking for the proposed Digital PLL while for normal Digital PLL it is in the range of mseconds. The above figure was deduced from different points by

changing input frequency by step of 1 Mhz, where a high locking speed was noticed.

6. References

- IEEE High Speed PLL frequency synthesizer for Mobile communication by Akihiro Kajiwara & Massao Nakagawa 1992
- IEEE A New PLL-FM Modulator with rapid acquisition time by Akihiro Kajiwara & Massao Nakagawa 1990
- Switched Capacitor PLL Frequency synthesizer by M.Abou El-Ela NRSC 99.
- Phase locked loops Theory, Design and applications by Roland Best "Mgcrohill" 1984.