

Multiple Reflector Dish Antennas

Paul Wade W1GHZ ©2004
w1ghz@arrl.net

Introduction

A dish antenna with multiple reflectors, like the Cassegrain antenna at OH2AUE¹ in Figure 1, looks like an obvious solution to one of the major problems with dishes, getting RF to the feed. With a conventional prime-focus dish, the feed is at the focal point, out in front of the parabolic reflector, so either a lossy feedline is necessary or part of the equipment is placed near the feed. The latter is reasonable for receiving systems, since low-noise amplifiers are quite compact, but high-power transmitters tend to be large and heavy.

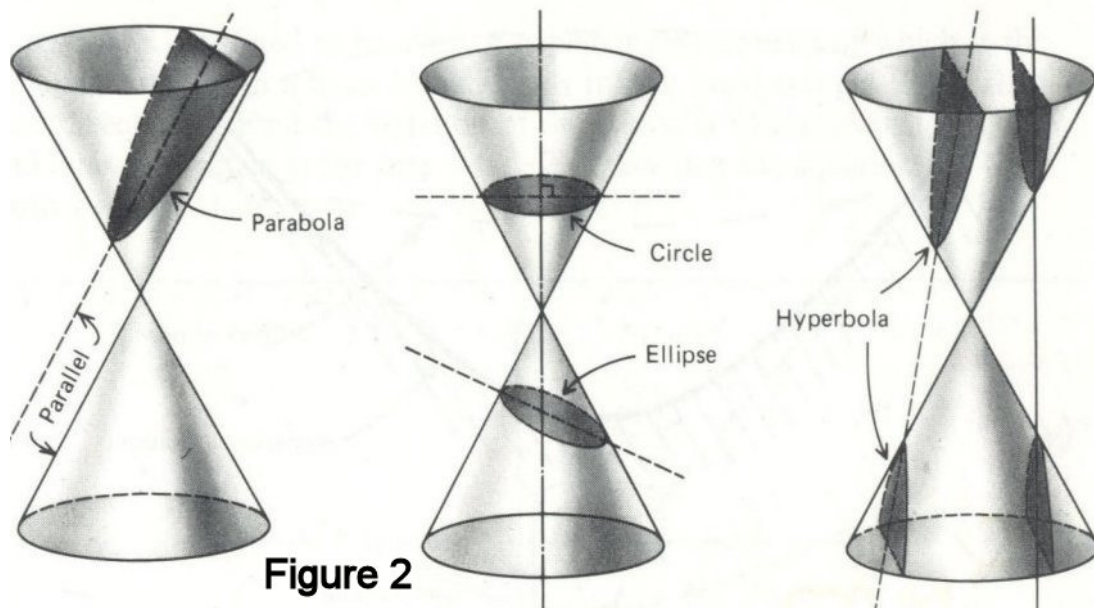

Figure 1

The Cassegrain antenna and similar multiple-reflector dishes allow the feed to be placed at a more convenient point, near the vertex (the center of the parabolic reflector) with the feedline coming through the center of the dish. However, further analysis shows that this advantage is merely a convenience; the real advantage is that the secondary reflector may be used to reshape the illumination of the reflector for better performance. Reshaping the illumination is particularly significant for very deep dishes, since there are NO good feeds for f/D less than ~ 0.3 , while there are a number of very efficient feeds for shallow dishes, with $f/D > 0.6$. By proper shaping of the subreflector, we may use a good feed to efficiently illuminate a deep dish.

Our tour of multiple-reflector dishes will analyze the common Cassegrain and Gregorian configurations in some detail, then review some other types that amateurs are unlikely to build, but might someday find as surplus. We shall see that multiple-reflector dishes work very well when the reflectors are large. For smaller dishes, we must make compromises which reduce efficiency; however, we can make some approximations which allow us to quantify the losses, so that we can make a reasonable judgment as to whether the results are worth the additional complexity.

Geometry



Reflector antennas utilize curvatures called conic sections², since they are shapes found by slicing a cone, as shown in Figure 2. In addition to the parabola, the other shapes are the circle, the ellipse, and the hyperbola. We will draw them as plane curves, in two dimensions, but useful reflector shapes are three-dimensional, generated by rotating the plane curve around an axis of symmetry.

The most useful reflector is the parabola, shown in Figure 3. The parabola has the valuable property that rays of light or RF emanating from the focus are all reflected to parallel paths, forming a narrow beam. All paths from the focus to a plane across the aperture, or a parallel plane at any distance, have the same length — take a ruler to Figure 3 and verify it. Since all the rays have the same path length, they are all in phase and the beam is coherent. This behavior is reciprocal — rays from a distant source are reflected to a point at the focus. The axis of symmetry for the parabola is the axial line through the vertex and the focus; if we spin the parabolic curve around this axis, we get the familiar parabolic dish.

The multiple-reflector systems were originally developed as optical telescopes³, long before radio. Thus, we will start with a quick overview of telescope designs. All of them have the same important property — ray paths must all have the same length.

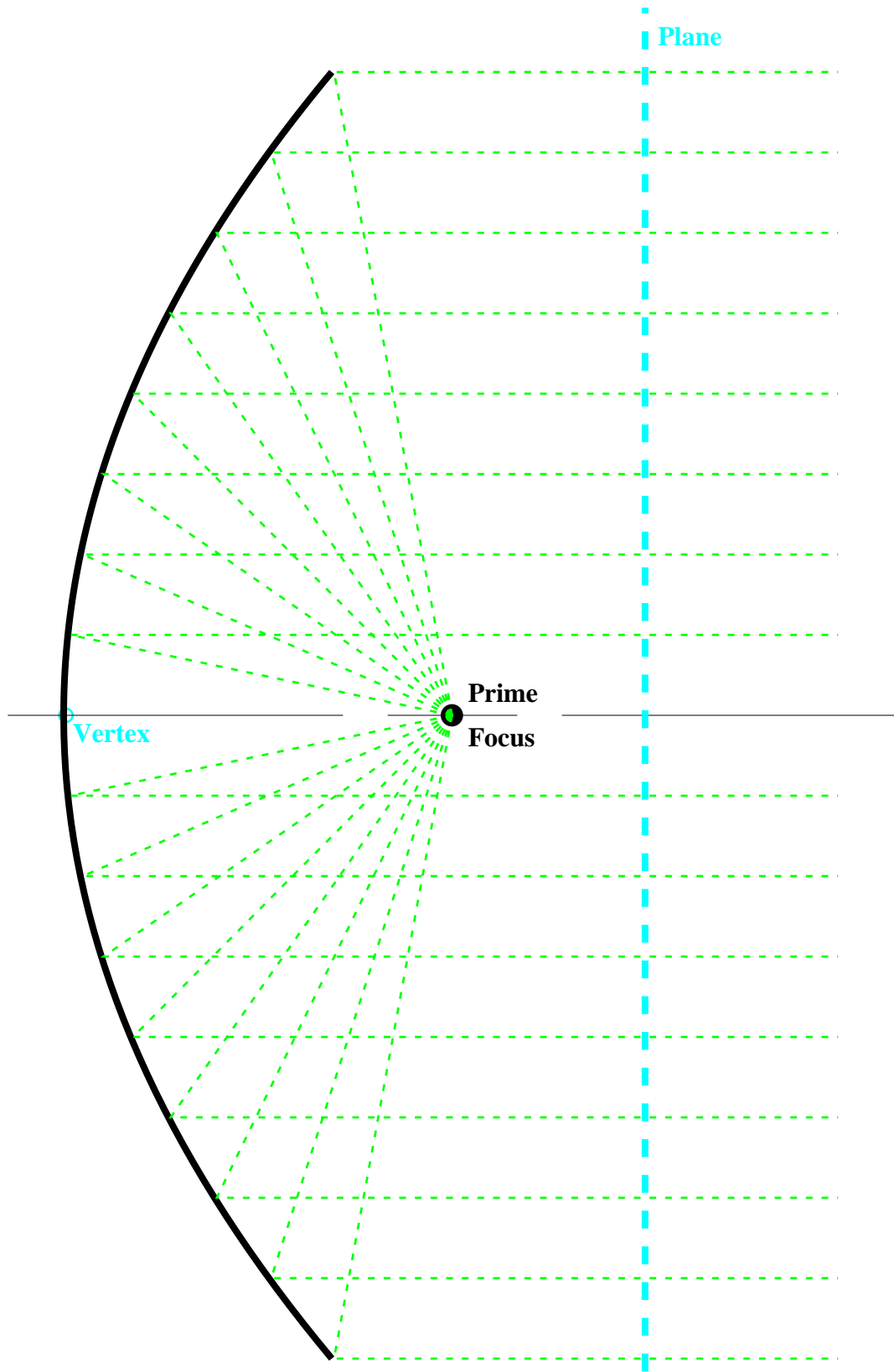
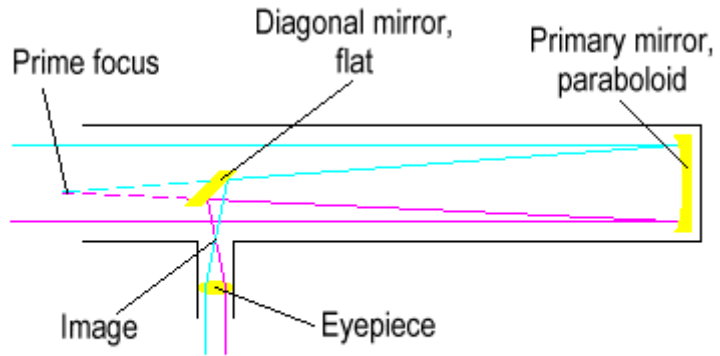

Figure 3. Parabolic Dish Geometry

The Newtonian telescope (Isaac Newton, 1668⁴) in Figure 4 is just a single parabolic reflector. A plane secondary reflector at an angle is added to get the observer's head (at the focal point) out of the optical path, but a plane reflector has no optical effect other than the change of direction. A dish antenna could also use a plane reflector to redirect the focus, but only if the focal length were long enough to move the focus out of the beam.



NEWTONIAN TELESCOPE

Figure 4

The difference is that a typical telescope has a long focal length, perhaps eight times the reflector diameter ($f/8$ in optical terminology, or $f/D = 8$ in antenna terminology), while a typical dish antenna has a focal length less than half the reflector diameter ($f/D < 0.5$).

The Gregorian telescope (James Gregory, 1663⁴) in Figure 5 adds an elliptical subreflector to reshape the beam, shortening the telescope, and to move the focus to a convenient point behind the center of the reflector.

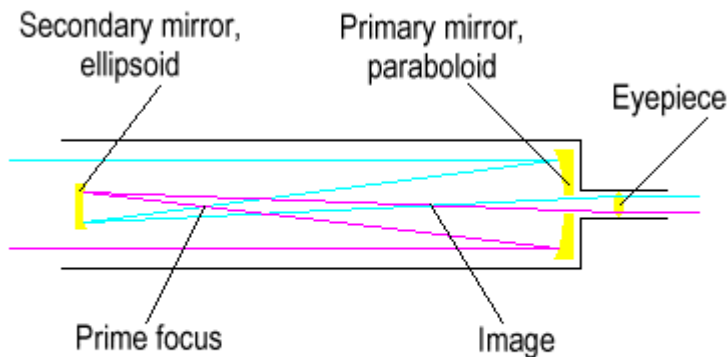

GREGORIAN TELESCOPE

Figure 5

changed by adjusting the curvature of the ellipse. For an antenna, we may place an efficient feedhorn with a narrow beam at the first focus and choose an ellipse that reshapes the beam into a broad one to illuminate a deep dish. The broad beam appears to come from the second focus, so we must make the second focus coincident with the focal point of the main parabolic reflector.

behind the center of the reflector. An ellipse has two foci, with the useful property that a ray emanating from one focus is reflected to pass through the other focus, as shown in Figure 5b. If most of the ellipse is removed, then rays from the first focus appear to radiate from the second, but angle may be

Figure 5b

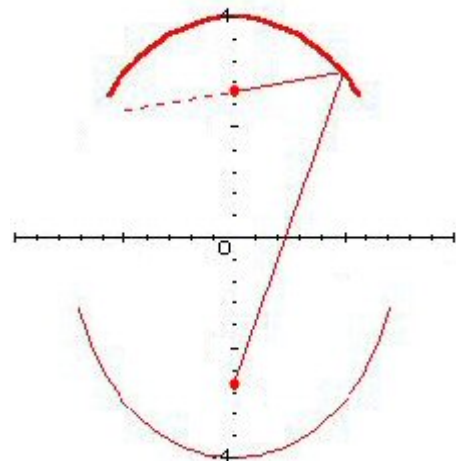

The Cassegrain telescope (attributed to M. Cassegrain, 1672, although he is not known to have published anything⁴) in

Figure 6 has a hyperbolic subreflector rather than elliptical, but having the same function. The hyperbola consists of two mirror-image curves and also has two foci, as shown in Figure 6b. The curves are between the two foci; for a reflector, only one curve is needed. Rays emanating

from the focus on the convex side of the curve are reflected by the hyperbola so that they appear to come from the other focus, behind the reflector. The focus behind the reflector, on the concave side, is referred to as a virtual focus, because the rays never reach it. Since the rays appear to radiate from the virtual focus, we must make it coincident with the focal point of the main parabolic reflector. The curvature of the hyperbola may also be adjusted to reshape the beam as required.

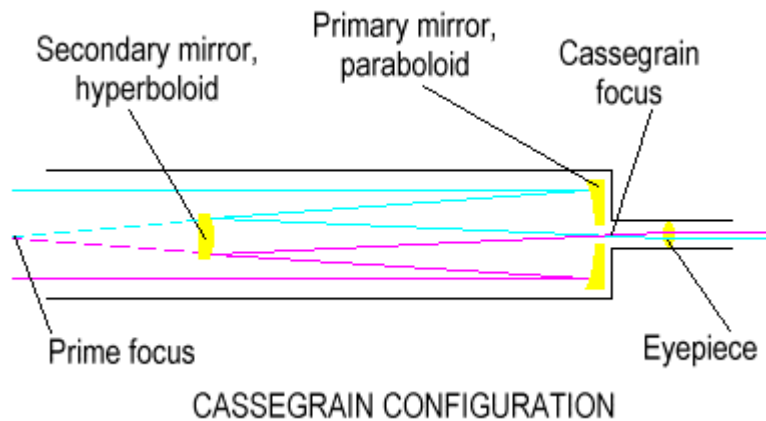

Figure 6

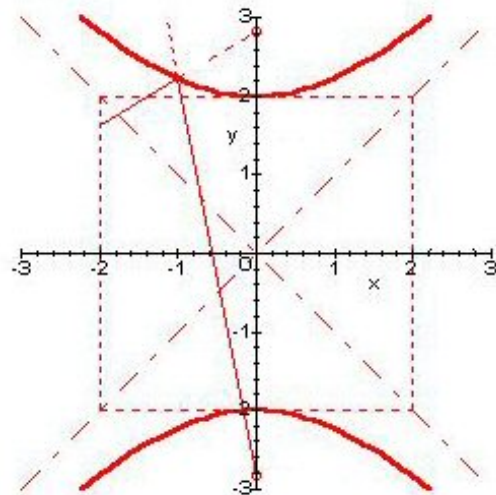

Figure 6b

The final conic section, the circle, is also used for telescopes and antennas, as a spherical main reflector and hyperbolic subreflector. A sphere is a much easier shape to fabricate than a parabola, and there is only a small difference between the two curves if the focal length is much longer than the diameter — classical lens design depends on this approximation!

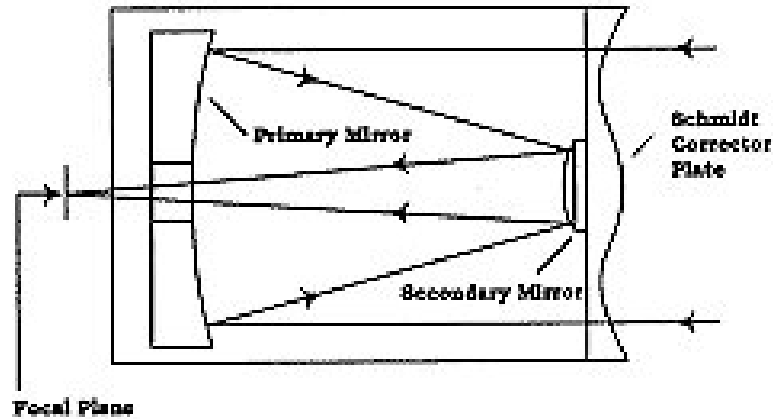
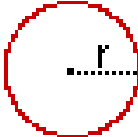
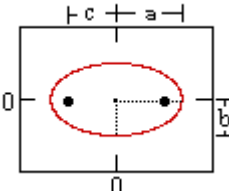
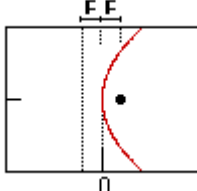
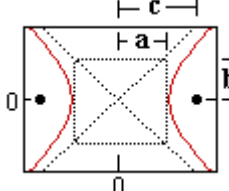

Figure 7

A Schmitt-Cassegrain telescope⁵ (Figure 7) has a spherical reflector rather than parabolic, and compensates for the difference with a "corrector plate" in front of the aperture. The corrector plate is a sheet of plastic whose thickness is varied to compensate for the error in path lengths caused by the spherical curve and make the total path length of all rays identical. In commercial versions, the hyperbolic subreflector is molded into the corrector plate. The Arecibo radiotelescope has a spherical reflector 1000 feet in diameter, making a long focal length impractical. The focus of a spherical reflector is an axial line rather than a point, so special feeds are required; depending on frequency, either a line feed or a specially-shaped subreflector.

We will examine these antenna designs in more detail later, as well as some other variations not commonly used in telescopes. All of them rely on the three basic shapes: the parabola, the ellipse, and the hyperbola. A summary of the properties of the conic-section shapes is given in Table 1:

	Circle	Ellipse	Parabola	Hyperbola
Equation	$x^2 + y^2 = r^2$	$\frac{x^2}{a^2} + \frac{y^2}{b^2} = 1$	$y^2 = 4fx$	$\frac{x^2}{a^2} - \frac{y^2}{b^2} = 1$
Geometry		$a^2 - b^2 = c^2$		$a^2 + b^2 = c^2$
Focal length	$f = 0$	$f = 2c$	$f = f$	$f = 2c$
Eccentricity	0	$e = c/a$		$e = c/a$
Eccentricity range	$e = 0$	$e < 1$	$e = 1$	$e > 1$
Magnification		$M = \frac{1+e}{1-e}$		$M = \frac{e+1}{e-1}$
Sketch				

Diffraction, or why small dishes don't work well

The design of multiple reflector antennas is derived from telescopes⁶ and other optical systems, so we use the quasi-optical design techniques of Geometric Optics⁷. For these approximations to be valid, three basic assumptions must be satisfied:

1. Wavelength is much smaller than any physical dimensions, so that we may use the approximation of zero wavelength.
2. Waves travel in straight lines, called rays.
3. Reflection from flat surfaces follows the Law of Reflection: the angle of incidence = the angle of reflection. See Figure 8.

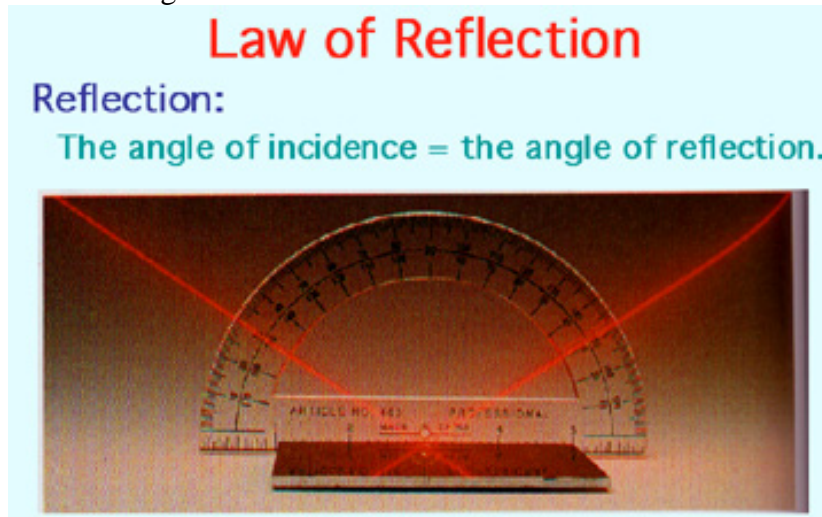

Figure 8

4. Refraction follows Snell's law shown in Figure 9 (a dielectric is required for refraction).

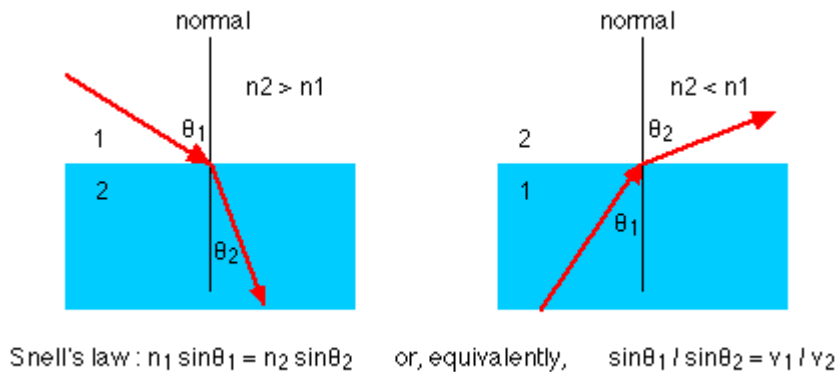

Figure 9

A good pictorial description of refraction is available on the web page⁸ of Prof. Joseph F. Alward of the University of the Pacific.

Many of the small dishes used by hams stretch the limits of these assumptions; performance may be compromised, but still usable. A typical dish might be only ten wavelengths in diameter or even smaller. Any usable feed has an effective electrical size larger than half a

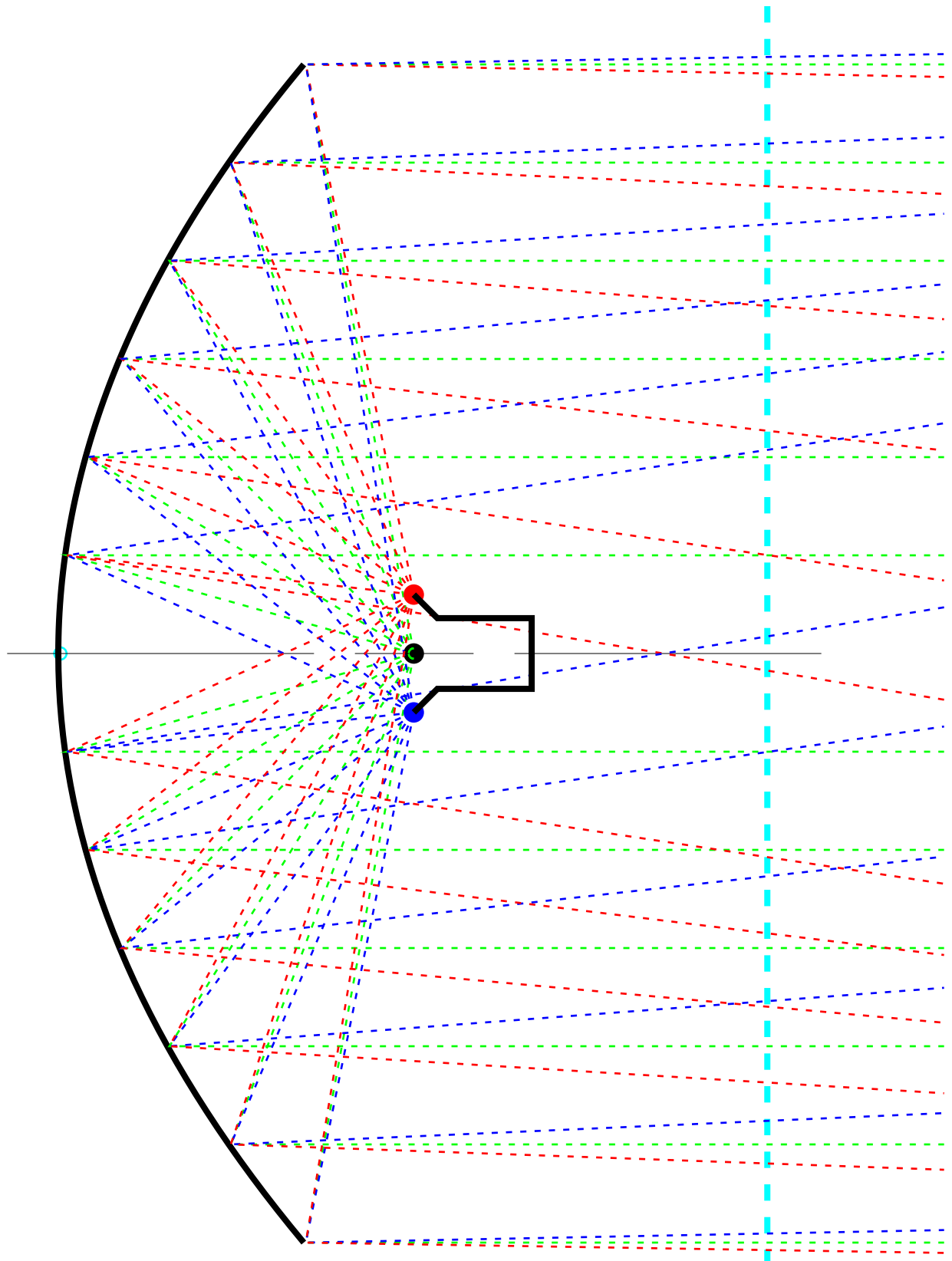

Figure 10. 10λ Diameter dish with Aperture source

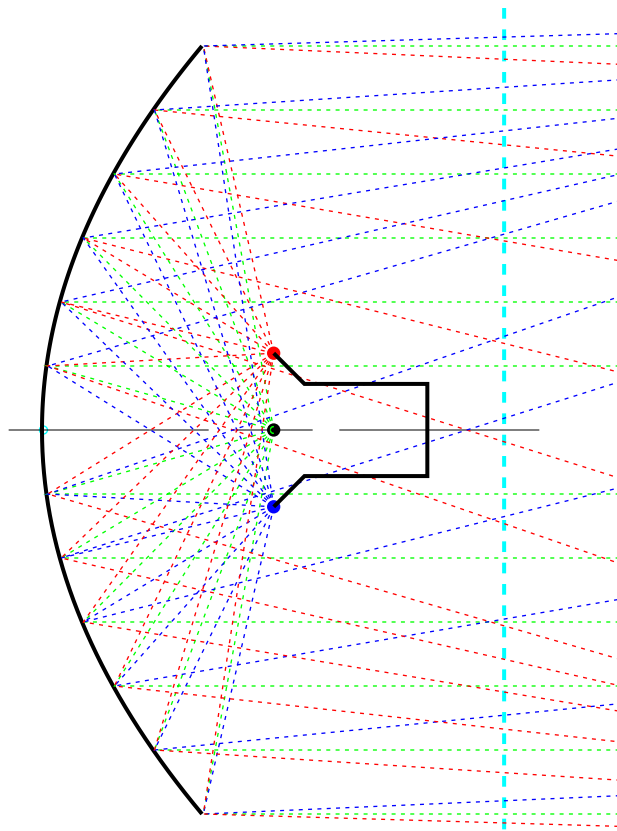

Figure 11a. 5λ Diameter dish with Aperture source

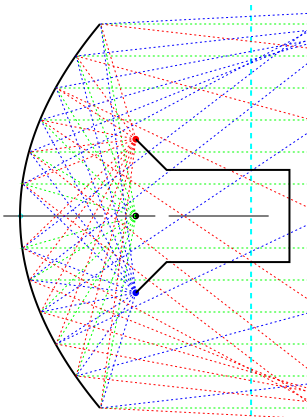

Figure 11b. 2.5λ Diameter dish with Aperture source

wavelength, so the feed is much larger than a point source. According to Huygen's Principle⁹, each point on a propagating wavefront can be considered as a secondary source radiating a spherical wave. The propagating wavefront could be the aperture of a feedhorn. Figure 10 shows a 10λ diameter dish with rays emanating from points across the aperture rather than a single point. The result is that the rays from the parabolic reflector are no longer parallel, but rather spread out into a diverging beam. Note that rays reflecting near the center of the parabola diverge more than rays farther from the center; from this, we might infer that that smaller dishes would have even broader beams. Figure 11 shows smaller dishes, 2.5λ and 5λ in diameter; as we expect, the beam becomes broader as the antenna gets smaller.

J. B. Keller (1985) described¹⁰ diffraction as any process whereby electromagnetic wave propagation differs from Geometric Optics. In addition to the diverging beam illustrated in Figures 10 and 11, diffraction effects are found when a wave encounters an obstacle or discontinuity. In a dish antenna, the feed and support struts, are obstacles, and the edges of reflectors are obvious discontinuities. Reflections are true from large flat surfaces, but curves must have a radius of curvature much larger than a wavelength to be a good reflector; otherwise, diffraction occurs.

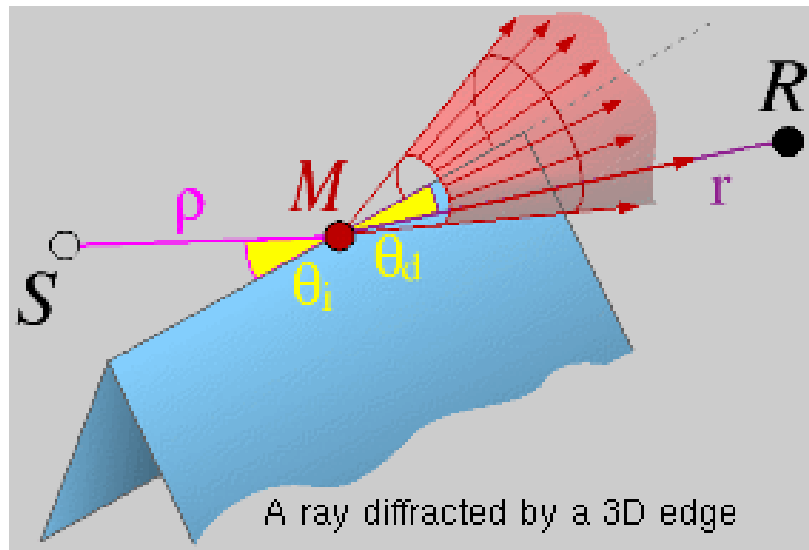
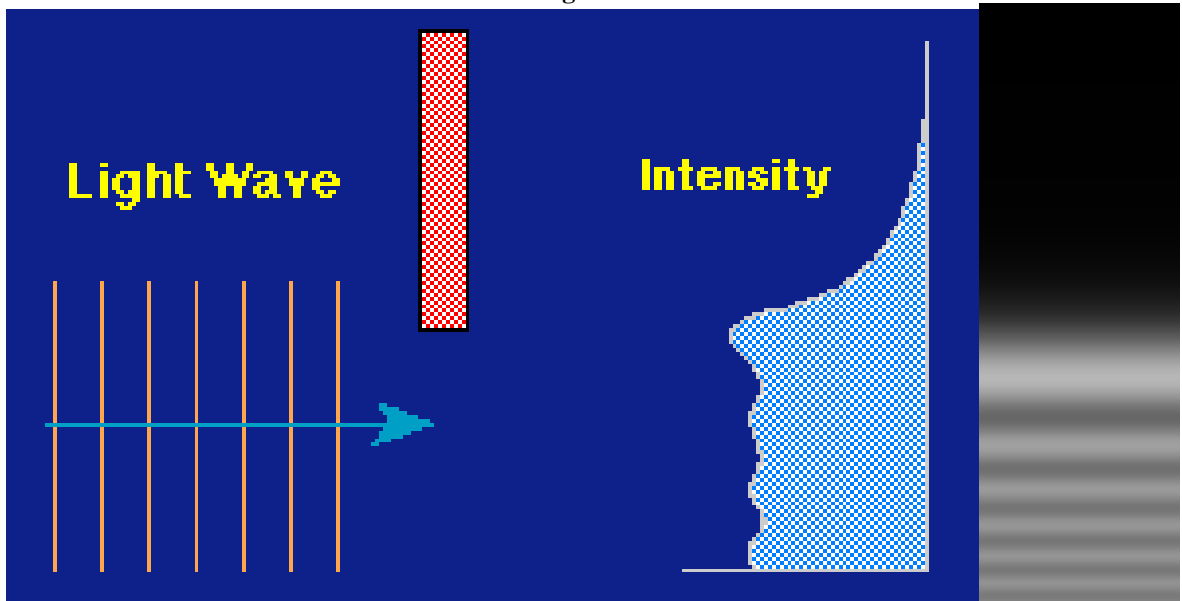

Figure 12

Keller¹¹ formulated the mathematical description of diffraction, which he called the *Geometrical Theory of Diffraction*. He showed that a ray encountering an edge is diffracted into a cone, as illustrated in Figure 12. The cone is commonly referred to as a Keller cone.

Hams seem to refer to all diffraction as “knife-edge” diffraction. Edge diffraction was the first type to be solved; the math is even more difficult for other shapes. The rays diffracted by the edge form a characteristic pattern of light (higher intensity) and dark (lower intensity) bands shown in the right side of Figure 13. The left side of the figure is an explanatory sketch – the diffraction at the edge acts as a secondary source (Huygen’s Principle) radiating into both the shadowed region at the top, where the intensity decreases with distance, and into the unshadowed region, where it forms an interference pattern with the direct light wave. The light and dark bands are the interference pattern. Note that diffraction affects all regions, not just the shadow.

Figure 13



Rays passing through a narrow slit are diffracted to both sides, forming an interference pattern between waves diffracted from the two sides, shown in Figure 14. The distance between peaks and nulls is proportional to the slot width w in wavelengths⁷; expressed as an angle, $\theta = \lambda/w$.

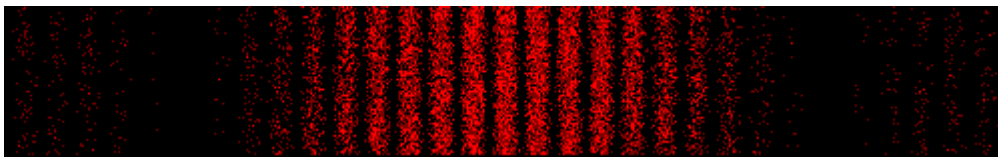

Figure 14

The diffraction pattern from a hole, Figure 15, occurs so frequently in optics that it has a name, the Airy diffraction pattern⁷. The spacing of light and dark rings is proportional to the diameter **D** in wavelengths; expressed as an angle, $\theta = 1.22\lambda/D$.

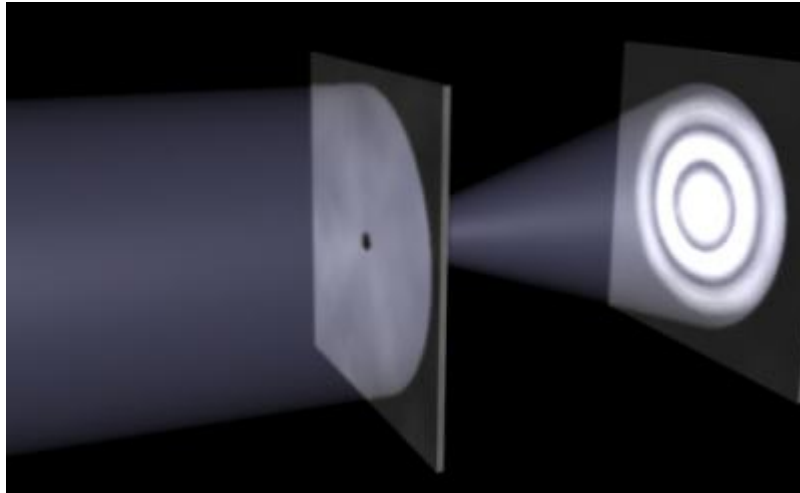

Figure 15

While experimenting with a laser pointer reflecting from a dish, I found that diffraction from a strut appears to form a Keller cone, captured in the photo of Figure 16.

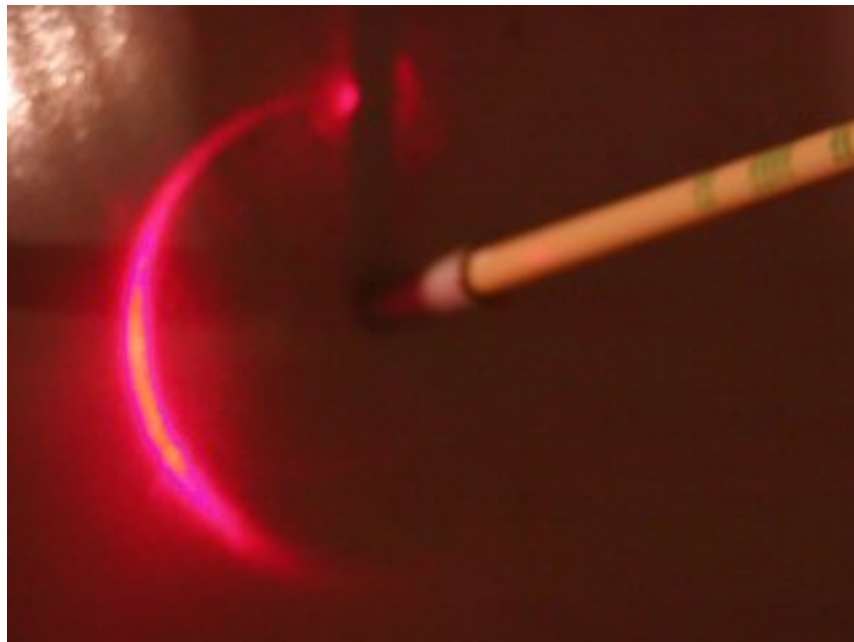

Figure 16

Telescopes suffer from all these diffraction effects. The image in Figure 17 shows Airy rings around star and diffraction from the mirror struts as radial lines around the star.



Figure 17

Diffraction from complex shapes may be roughly estimated as combinations of these simple shapes. We can also estimate the inverse shapes using Babinet's Principle¹², so that diffraction from a round disc is the complement of a round hole, with the light and dark regions interchanged.

Antenna Design

Given all this geometry and diffraction, can we use it to design an antenna? Probably not — the math needed for accurate calculation of diffraction is *very* difficult; in three dimensions⁹, the integral signs are six deep! Most books use Tensor notation; more concise, but no easier.

A more useful approach is a set of working approximations that are reasonably accurate for moderate and large dishes. When we stretch the approximations to small dishes, there may be some error, but we are still better off than just guessing.

We will put the approximations together into a design procedure for the Cassegrain antenna, including several examples. The approximations will be shown as graphs, and also included in a spreadsheet format as a design aid.

The design procedure will then be extended to the Gregorian antenna; the Cassegrain and Gregorian are the two multiple-reflector antennas most likely to be homebrewed by amateurs.

Other, more complex types, of multiple-reflector antennas are in service and may someday show up as surplus. We will describe several of them so that you might recognize them if the occasion arises.

Cassegrain Antenna Design Procedure

Why do we need a complicated design procedure? Design of a prime focus dish antenna is relatively straightforward: first, choose a feed which fully illuminates the parabolic reflector but no more, as shown in Figure 3. Then position the phase center of the feed at the focal point of the parabola. The Cassegrain antenna adds a hyperbolic subreflector to this arrangement, acting as a mirror to reflect the feed position back toward the main reflector. The difficulty is finding the right hyperbolic subreflector to match the main reflector to the feed, since the hyperbola is not a single curve, but a whole family of curves with different focal lengths and curvatures. The amount of curvature is called eccentricity. From this family, we must find the unique hyperbola which matches the parabola and feed so that the path lengths shown in Figure 3 all remain equal.

The optimum design of a complete Cassegrain antenna system is rather complicated, but some published descriptions use mathematics which makes it seem even more complicated. If one is designing an antenna system from scratch on a clean sheet of paper, the combination of two reflectors plus a feedhorn has sufficient degrees of freedom to permit many good solutions. Most amateur antennas have a more definite starting point: the availability of a good dish or a good subreflector. The problem is then simplified to the optimum design of the other components. Another important question is whether the Cassegrain system is any better than a conventional prime-focus antenna using the same dish.

Some of the published descriptions are quite clear and direct, except that they seem to pluck some key dimensions out of thin air. For instance, an otherwise excellent recent paper by G7MRF¹³ arrived at a subreflector diameter of exactly 100 mm without explanation. Other than this revelation, his paper was well done, and is recommended reading.

I have found two descriptions, one by Jensen¹⁴ and one by Milligan¹⁵, which are reasonably clear and complete; I will attempt to synthesize them into a straightforward design procedure for the first case, starting with a known dish and calculating an appropriate subreflector geometry. Since there are several tradeoffs involved, I will use a spreadsheet format — useful for quick calculations. First, however, we will walk through the design procedure to understand what the spreadsheet is calculating and see where the tradeoffs are made. Later, we will look at some real examples. The dimensions and angles are shown in the Cassegrain geometry of Figure 18.

Jensen's emphasis is on high performance — the additional complexity of a Cassegrain should provide some benefit. To minimize loss from diffraction and spillover, he suggests that the subreflector be electrically large, greater than 10 wavelengths in diameter, or about 1 foot at 10 GHz. The subreflector diameter should be less than 20% of the dish diameter to minimize blockage by the subreflector, so the dish should be larger than 50 wavelengths diameter. Jensen includes curves to help in comparing the various losses to make tradeoffs. The curves clearly show antenna efficiency decreasing rapidly for subreflectors smaller than ten wavelengths and for diameter ratios greater than 0.1.

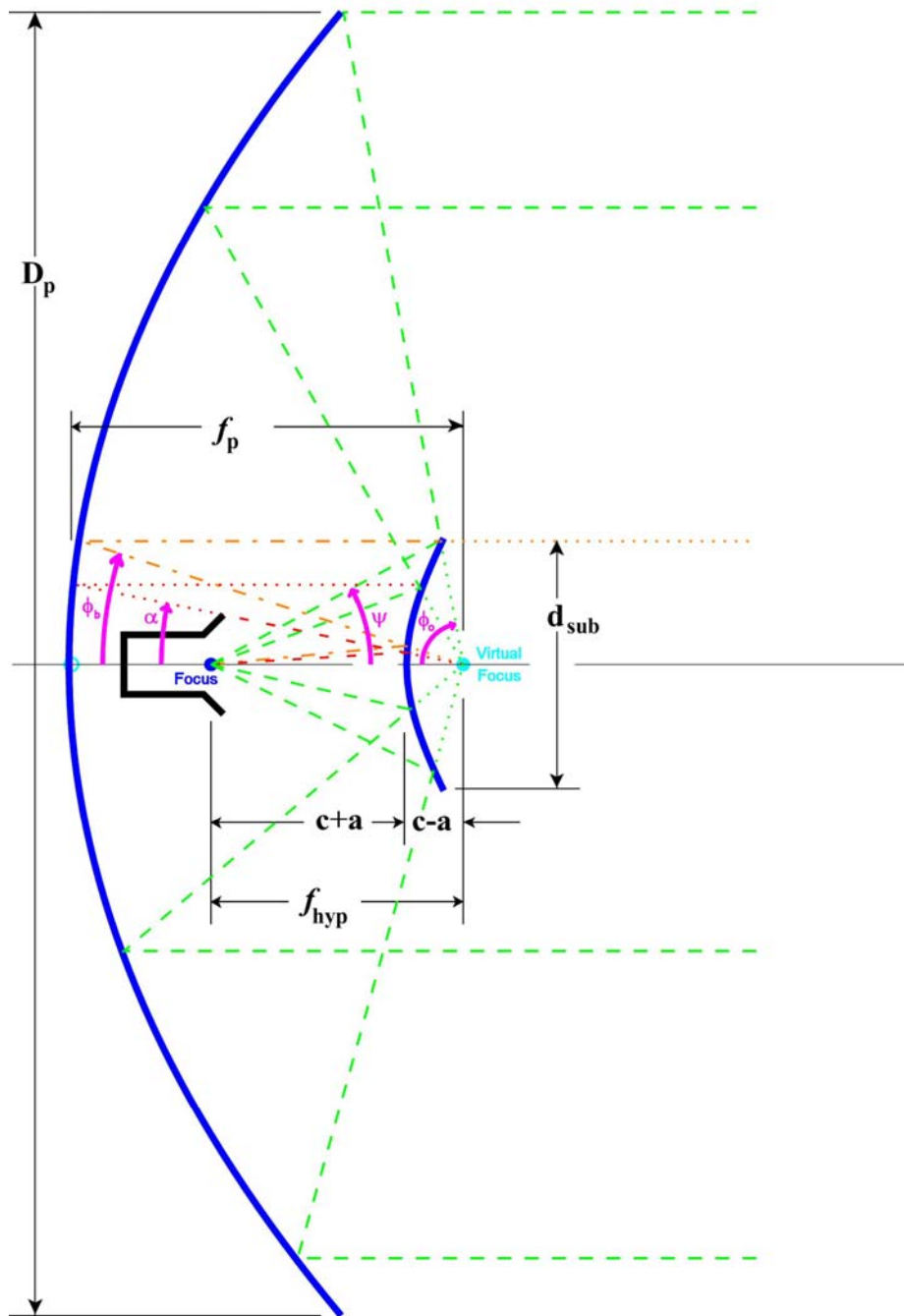

Figure 18 - Cassegrain Antenna Geometry

Variables in Figure 18:

D_p = Parabolic dish diameter
 f_p = Parabolic dish focal length
 d_{sub} = Subreflector diameter
 f_{hyp} = focal length of hyperbola – between foci
 a = parameter of hyperbola – see sketch in Table 1

$c = f_{hyp} / 2$ = parameter of hyperbola
 ϕ_o = angle subtended by parabola
 ψ = angle subtended by subreflector
 ϕ_b = angle blocked by subreflector
 α = angle blocked by feedhorn

However, lower efficiency is sometimes tolerable. For very deep dishes where available feeds can only provide poor efficiency, a Cassegrain system with a good feedhorn might achieve better overall efficiency. At the higher microwave frequencies, feedline loss can be high enough to significantly reduce overall efficiency, so the more accessible feed location of the Cassegrain system might be a good alternative. If we can quantify these losses, then we can make intelligent comparisons and tradeoffs.

1. Optimum edge taper

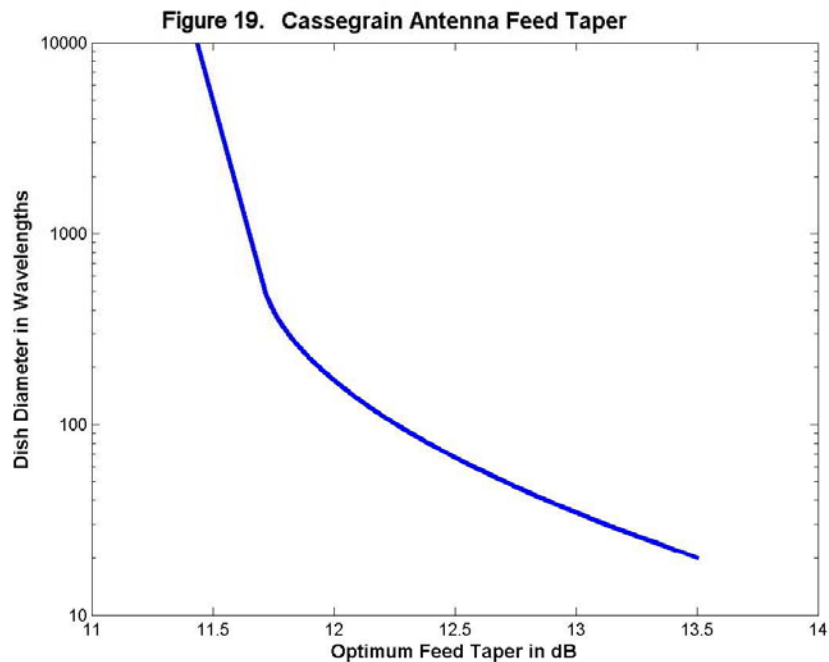

Milligan includes approximations for the losses in smaller dishes, based on the work of Kildal¹⁶. Diffraction is a major contributor to losses in small dishes. Kildal found that the illumination edge taper in a Cassegrain feed should be somewhat greater than the nominal 10-dB edge taper for a prime-focus dish, to reduce diffraction loss. Since diffraction occurs near the edge of a reflector, reducing the edge illumination should reduce the diffracted energy, while the illumination loss increases slightly. No closed-form equation is given, only a plot like Figure 19, which shows the optimum illumination taper vs. dish diameter. While other sources¹⁷ suggest up to 15 dB edge taper, the curve in Figure 19 gives the optimum taper as about 14 dB for small dishes, decreasing to about 11 dB for very large dishes. We will realize this optimum edge taper by adjusting the feedhorn position.

2. Optimum subreflector size

Kildal then derived a formula for the optimum subreflector size to minimize the combination of blockage and diffraction losses:

$$\frac{d_{\text{sub}}}{D_p} = \left[\frac{\cos^4\left(\frac{\psi}{2}\right)}{(4\pi)^2 \sin \phi_0} \cdot E \frac{\lambda}{D_p} \right]^{1/5} \quad \text{where } E \text{ is the edge taper as a ratio: } E = 10^{\left(\frac{\text{taper in dB}}{10}\right)}$$

assuming the optimum dish taper from Figure 19. This formula is plotted in Figure 20, allowing us to find the optimum d/D , the ratio of subreflector diameter to dish diameter, for any size dish and edge taper.

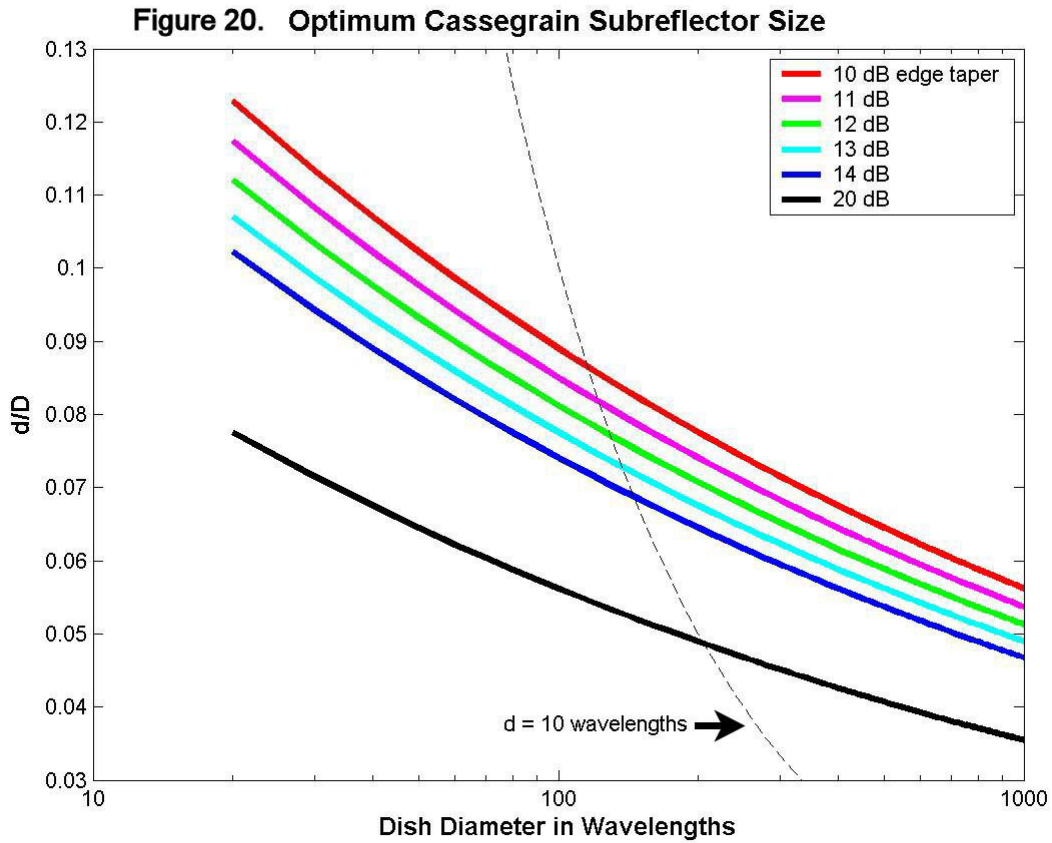

3. Approximate subreflector efficiency

Finally, Kildal calculates the approximate efficiency for the combination of blockage and diffraction losses:

$$\eta = \left[1 - C_b \left(1 + 4 \sqrt{1 - \frac{d_{\text{sub}}}{D_p}} \right) \cdot \left(\frac{d_{\text{sub}}}{D_p} \right)^2 \right]^2 \quad \text{where } C_b = \frac{-\ln(\sqrt{E})}{1 - \sqrt{E}}$$

again assuming the optimum dish taper and subreflector size. An additional assumption is that the feed illumination angle subtended by the subreflector is fairly small, $\psi < 30^\circ$. The approximate efficiency is plotted in Figure 21.

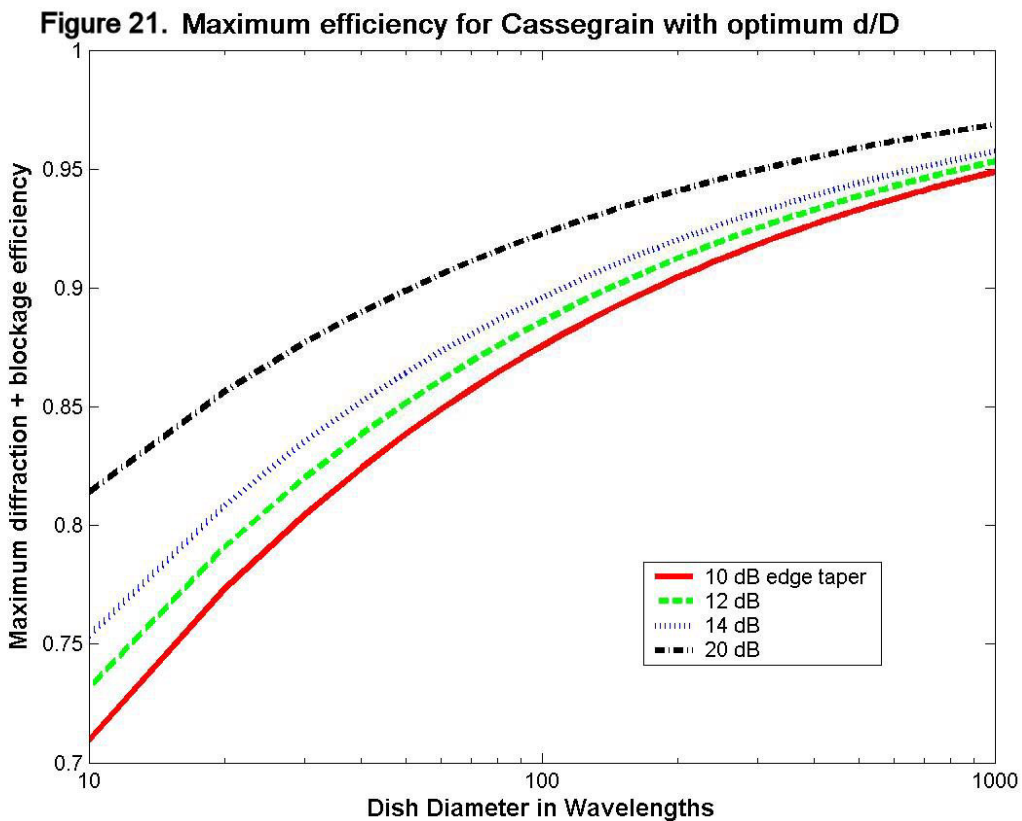

The above efficiency is just for the Cassegrain subreflector. The subreflector reduces the antenna efficiency, so the total antenna efficiency may be estimated by multiplying this efficiency by the normal estimated dish efficiency – perhaps from a **PHASEPAT**¹⁸ plot for the feedhorn. However, the system efficiency may still be better than with a primary feed, particularly with very deep dishes, where no good feeds are available. With a Cassegrain system, we may be able to use an excellent feedhorn, so that the feedhorn improvement is better than the Cassegrain efficiency loss. If we can also reduce feedline loss by making the feed location more convenient, so much the better.

If these numbers are acceptable, then we can proceed with the design of the Cassegrain antenna, with the geometry shown in Figure 18.

4. Feedhorn

The next step is to choose a feedhorn. Then we can calculate the hyperbola dimensions for the subreflector necessary to reshape the feedhorn pattern to properly illuminate the dish, as well as the desired hyperbola focal length, the distance between the two foci of the hyperbola. Looking at Figure 18, one focus of the hyperbola is at the focal point of the dish; we will refer to this as the virtual focus. No RF ever reaches it, but the RF from the feed reflected by the subreflector appears to originate from the virtual focus. The feedhorn phase center is at the other focus of the hyperbola. The feedhorn illuminates the subreflector, which subtends the angle ψ . A feedhorn with a wide beam would be closer to the subreflector than a feedhorn with a narrow beam — later, we will calculate the hyperbola curvature for the desired focal length.

In the *WIGHZ Microwave Antenna Book — Online*¹⁸, various feedhorns are characterized by calculating the dish efficiency vs. f/D ratio. The f/D for maximum efficiency is the dish best illuminated by that feed. Since prime-focus dishes usually have maximum efficiency with about 10dB edge taper, we will assume that the best f/D for a feed is also where it provides illumination with about 10 dB edge taper.

The subtended half-angle to illuminate a given f/D is

$$\psi = 2 \tan^{-1} \left(\frac{1}{4 \cdot \frac{f}{D}} \right)$$

To adjust this for the edge taper we chose above, we use Kelleher's universal horn equation:

$$\psi' = \psi \cdot \sqrt{\frac{\text{taper in dB}}{10}} \text{ to correct the illumination angle for our desired edge taper.}$$

However, this does not account for the natural edge taper from Space Attenuation, which is significant in deep dishes, where the focus is much further from the rim than from the vertex. For an $f/D = 0.25$, the rim is twice as far away as the vertex, so the Space Attenuation (S.A.) is 6 dB by the inverse-square law. For other f/D ,

$$\text{S.A.} = 20 \cdot \log \left(\frac{2}{1 + \cos \psi} \right)$$

Now we can calculate the adjusted illumination angle to get the desired edge taper from our feedhorn:

$$\psi' = \psi \cdot \sqrt{\frac{\text{taper in dB} - S.A._{\text{Dish}}}{10 - S.A._{\text{Feed}}}}$$

5. Hyperbola focal length

Next, we must position the feed so the angle subtended by the subreflector is ψ' , while also placing the feed at one focus of the hyperbola and the dish prime focus at the other; see Figure 18. Thus, the hyperbola focal length, the distance between the two foci is

$$f_{\text{hyp}} = 0.5 \cdot d_{\text{sub}} \cdot (\cot(\psi') + \cot(\phi))$$

6. Feed blockage

We must also be concerned with feedhorn blockage, shown as angle α in Figure 18. Rays near the center of the beam that reflect from the subreflector at angles less than ϕ_b are eventually blocked by the subreflector. If $\alpha > \phi_b$, then the angle shadowed by the feedhorn is larger than the angle shadowed by the subreflector, so the feed will cause additional blockage loss.

$$\phi_b = \sin^{-1}\left(\frac{d_{\text{sub}}}{2 \cdot F_p}\right)$$

and

$$\alpha = \tan^{-1}\left(\frac{d_{\text{feed}}}{2 \cdot f_{\text{hyp}}}\right)$$

To eliminate feedhorn blockage, the feedhorn must be moved farther away from the subreflector. There are two ways to move the feedhorn without upsetting the geometry. One choice is a feedhorn with a narrower beam, reducing angle ψ (recalculate f_{hyp}); however, narrower beams require larger horn apertures, so this may not work. The other choice is a larger subreflector, which increases the focal distance without changing angle ψ . This will increase blockage loss only, so the efficiency will decrease slightly and should be recalculated. The minimum subreflector diameter to avoid feedhorn blockage is:

$$d_{\text{sub}} > d_{\text{feed}} \cdot \frac{f_p}{f_{\text{hyp}}}$$

If we know the phase center (PC) for the feedhorn, we may correct¹⁹ for it in the last two equations by replacing f_{hyp} with $(f_{\text{hyp}} + \text{PC})$, where a PC inside the horn is negative.

Once we have settled on a feedhorn and angle ψ , the effective f/d for the feed is:

$$\text{Effective feed } f/d = \frac{1}{4 \tan\left(\frac{\psi}{2}\right)}$$

7. Subreflector Geometry

The subreflector must reshape the illumination from the effective feed f/d to F_p/D_p for the dish, a magnification factor M :

$$M = \frac{\text{effective feed } f/D}{f_p/D_p}$$

(Some references add a virtual dish or equivalent dish with a focal length M times as long – if you prefer, the equivalent dish is the reflection of the main dish by the hyperbolic subreflector.)

This requires a hyperbola with an eccentricity e :

$$e = \frac{M + 1}{M - 1}$$

Finally, the hyperbola parameters (see sketch in Table 1) are calculated:

$$c = \frac{f_{\text{hyp}}}{2}$$

$$a = \frac{c}{e}$$

$$b = \sqrt{c^2 - a^2}$$

The distance from the apex of the subreflector to the virtual focus (the focus of the main parabola) behind the subreflector is $c-a$.

The distance from the apex of the subreflector to the phase center of the feedhorn is $c+a$.

A final check is to make sure the subreflector is in the far field of the feedhorn:

$$c + a > \frac{2 \cdot d_{\text{feed}}^2}{\lambda}, \text{ the Rayleigh distance; according to Wood}^{20}, \text{ having the subreflector in the}$$

near field of the feed will cause significant phase error. The error decreases as the spacing approaches the Rayleigh distance, so we can fudge a bit here. Distances as small as half the Rayleigh distance are probably usable without major loss.

8. Spreadsheet

The spreadsheet **cassegrain_design.xls**¹⁸ does all these calculations. Start by entering a dish diameter and F/D, plus feedhorn parameters. The spreadsheet will suggest feed taper and minimum subreflector sizes will be suggested. You may enter these values or choose others, adjusting them and the feedhorn parameters until an acceptable compromise is reached.

Remember that these calculations involve a number of approximations; error increases as we stretch the approximations, particularly with very small dishes. However, it is unlikely that losses will be less than estimated.

I have also written a Perl script, **Cass_design.pl**¹⁸, which calculates and draws a sketch to scale of each Cassegrain antenna, like the examples in Figures 22 and 24.

9. Subreflector profile

From the parameters of the subreflector geometry above, we may plot the subreflector profile using the equation for the hyperbola:

$y = \frac{b}{a} \cdot \sqrt{x^2 - a^2}$ and solving for a number of x, y pairs. The G7MRF paper¹³ includes a spreadsheet which will calculate a table of values and plot the curve. Just plug in the parameters a, b, and c. The Perl script, **Cass_design.pl**, will also plot a table of values.

EXAMPLES:

A while back an 8-foot dish with a bright blue radome appeared next to my driveway — my wife hates the color, so I had to hide it in the woods. The dish was previously used at 14 GHz, so it should work well at 10 GHz. The original feed was a small horn which would not provide good efficiency at 10 GHz, fed through a waveguide “buttonhook.” Because of the radome, a rear feed would be preferable. The dish has a focal length of 34.5 inches, so the f/D is 0.36. I also have a good corrugated feedhorn for an f/D of 0.75; the performance plot is shown in Figure 22.

The spreadsheet for this dish and feed combination is Figure 23. The suggested edge taper is 12.36 dB, which I saw no reason to change. This results in a minimum subreflector diameter of 6.94λ , but a larger diameter is needed to avoid feedhorn blockage, at least 8.47λ . The resulting estimated subreflector efficiency is 82.7%, or less than 1 dB loss due to the subreflector. It would take some effort to keep feedline losses to a feed at the focus below 1dB, so this is a promising result.

However, the subreflector is in the near field of the feedhorn, significantly closer than the Rayleigh distance. In order for the feedhorn to be far enough away, we must increase the subreflector diameter to 14.3λ , a substantial increase in blockage. This will reduce the

Corrugated horn for offset dish $f/D=0.75$ at 10.368 GHz

Figure 22

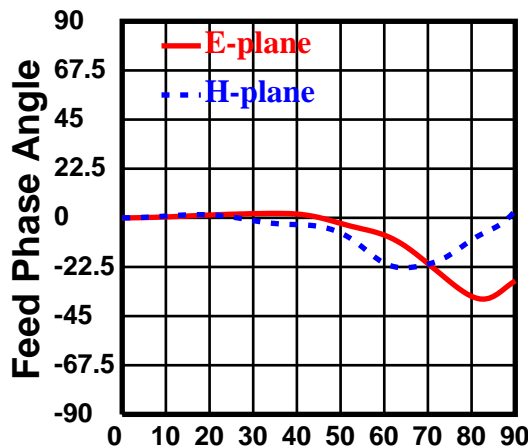
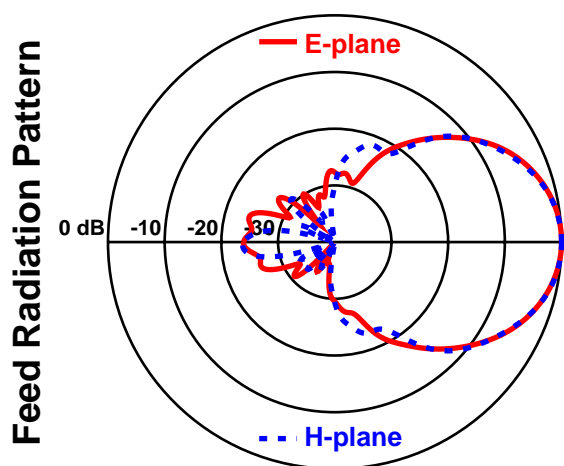

Dish diameter = 15.8λ Feed diameter = 0.5λ

Rotation Angle around specified Phase Center = 0.11λ inside aperture

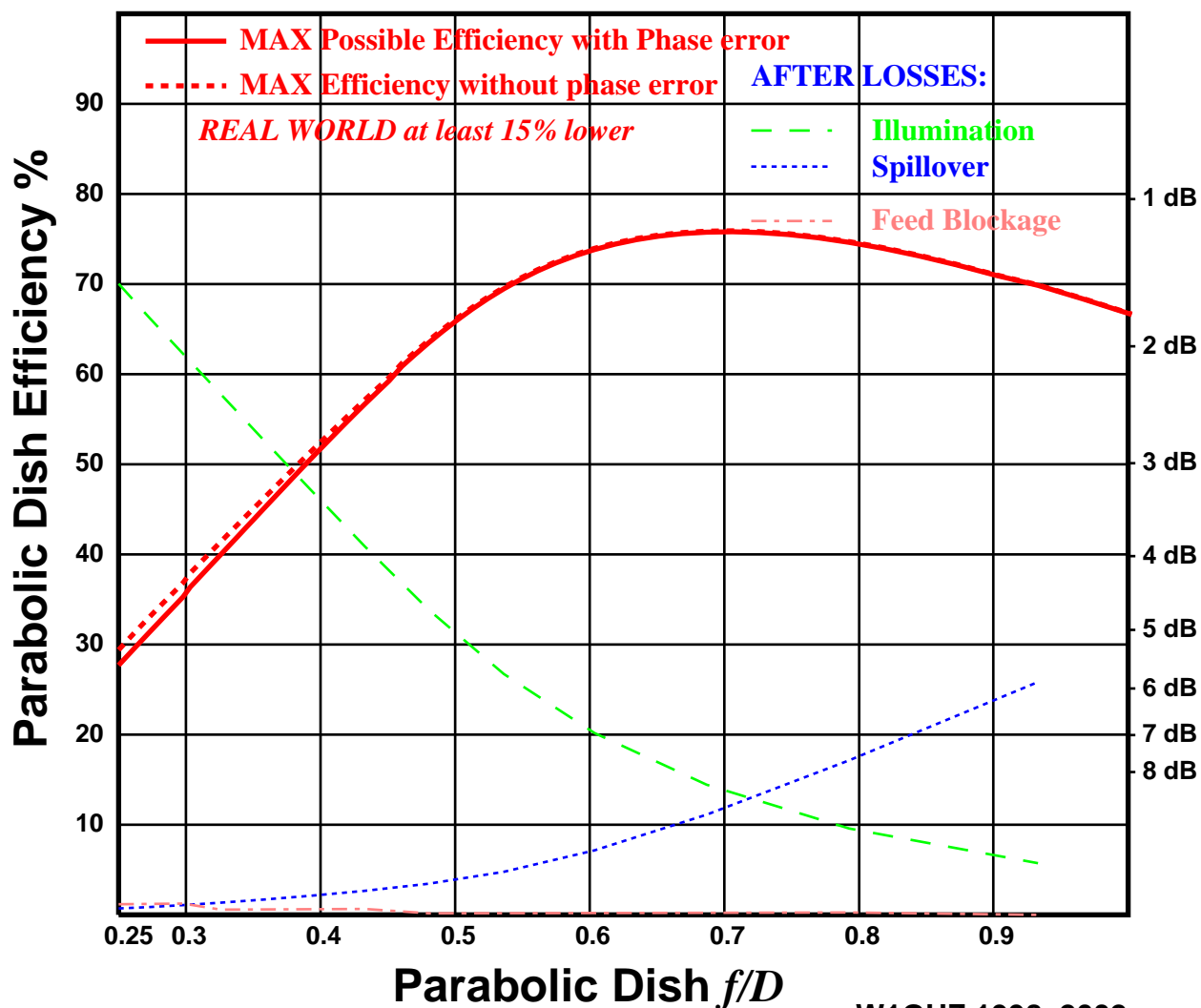

Figure 23

CASSEGRAIN ANTENNA DESIGN CALCULATOR

W1GHZ 2004

ENTER INPUT PARAMETERS HERE:

(Bold blue numbers)

Frequency

10.368

GHz

pi = 3.141593

Units:

mmInchesWavelengths

Dish diameter

2438

96.0

84.3

Dish f/D

0.36

Feedhorn equivalent f/D

0.75

Feedhorn diameter

59

2.323

2.03904

Feedhorn Phase Center (negative = inside horn)

-0.11**Wavelength****28.935**

1.139

1

Dish Focal Length

875.2

34.5

30.2

Dish Illumination halfangle

69.7

degrees

1.217 radians

Feedhorn illumination halfangle

36.9

degrees

0.644 radians

Redge (prime focus to rim)

1299.7

51.2

44.9

Space attenuation for main dish

3.43

dB

Space attenuation for virtual dish

0.92

dB

Decision point:**Suggested illumination taper = 12.36 dB****Enter desired illumination taper : 12.36 dB****With desired taper:**

Feedhorn illumination halfangle

36.5 degrees

0.638 radians

Feedhorn equivalent f/D

0.76

Minimum subreflector diameter

200.7

7.903

6.94

Subreflector focal length

172.5

6.792

5.96

Subreflector f/D

0.86

d_sub/D_main

0.08

Maximum subreflector efficiency (Diffraction loss = blockage loss)

88.1%

Feedhorn blockage halfangle

9.9

degrees

0.172 radians

Without feedhorn blockage -- increase subreflector diameter to eliminate feedhorn blockage:

Minimum subreflector diameter

245.1

9.650

8.47

Subreflector focal length

210.7

8.294

7.28

d_sub/D_main

0.10

Subreflector efficiency (Diffraction plus blockage losses)

82.7%

Feedhorn blockage halfangle

8.1

degrees

0.141 radians

Decision point:**Enter desired subreflector diameter : 14.3 in wavelengths****or go back and change feedhorn****With desired subreflector diameter:**

Subreflector focal length

355.6

14.001

12.29

d_sub/D_main

0.17

Subreflector efficiency (only blockage loss increases)

80.4%**Cassegrain loss = -0.947 dB**

**For overall efficiency, find efficiency on feedhorn PHASEPAT curve for f/D= 0.76
and multiply by 0.804**

CASSEGRAIN SUBREFLECTOR GEOMETRY:

Feedhorn blockage halfangle				4.7	degrees	0.083	radians
Subreflector magnification M				2.11			
Hyperbola eccentricity				2.80			
Hyperbola a	63.4	2.497	2.19				
Hyperbola b	166.1	6.540	5.74				
Hyperbola c	177.8	7.001	6.15				

SUBREFLECTOR POSITION:

Apex to Dish focal point	114.4	4.503	3.95
Apex to Feed Phase Center	241.2	9.498	8.34
Feedhorn Rayleigh distance =			8.32

Background calculations:

Optimum illumination taper for Cassegrain, from Kildal
from curve fitting 12.35920715

Optimum subreflector size, from Kildal (Diffraction loss = blockage loss)
E (voltage taper) 0.058076442
term 1 0.006332574
term 2 0.866861585
term 3 0.000689275
dsub over Dish diameter 0.082335006

Maximum Cassegrain efficiency for optimum d/D, from Kildal
ds_ratio 0.082335006
Cb 1.874808695
term 4 9.058688097
maximum efficiency 0.88095245
max_eff 0.88095245

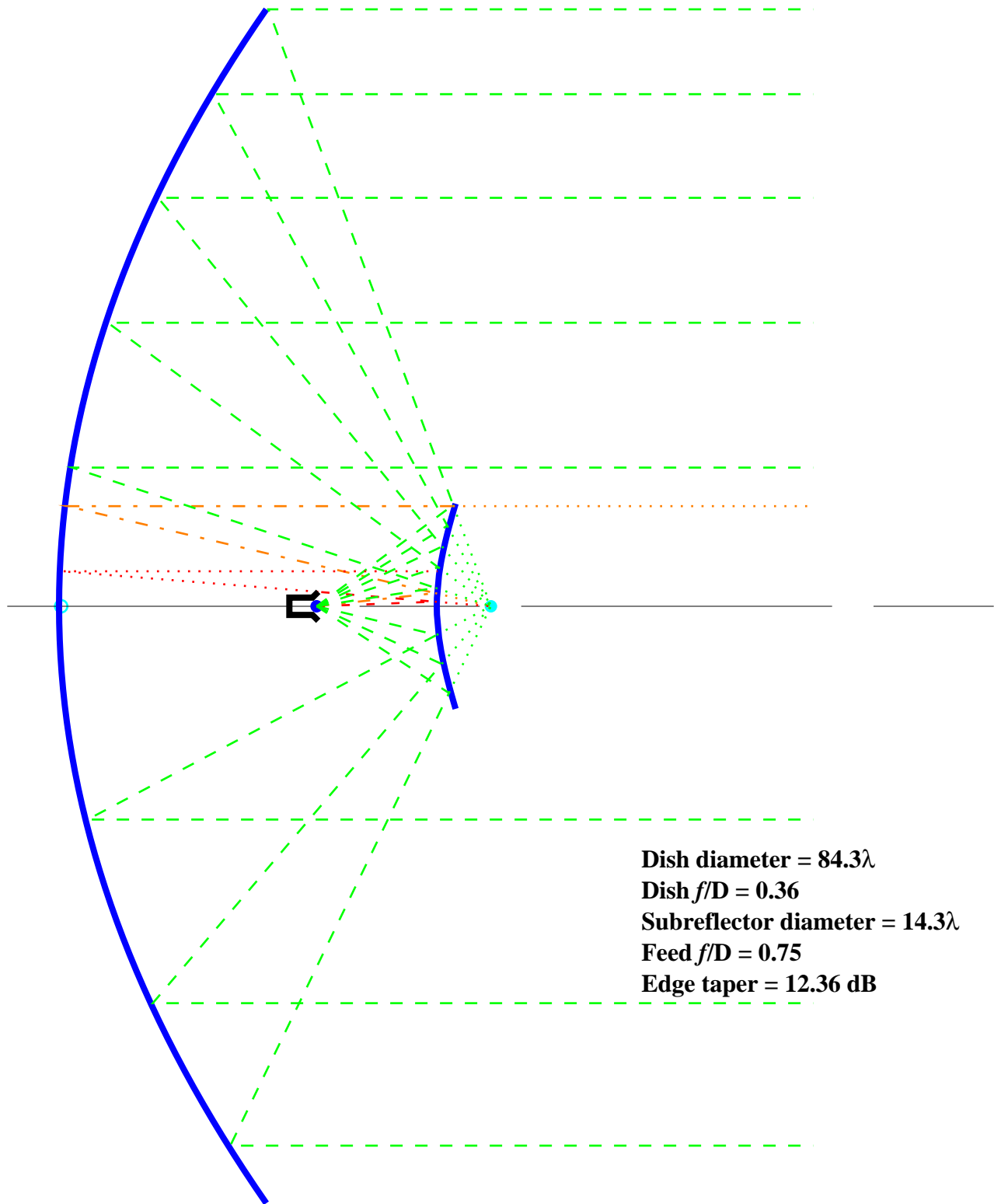

Figure 24. Cassegrain example: 8-foot dish at 10 GHz

subreflector efficiency to an estimated 80%, or just under 1 dB loss. When we multiply the subreflector efficiency by the calculated feedhorn efficiency, 75% at the effective f/D of 0.76, the net efficiency is about 60%. For the prime focus configuration to do any better than this, we would need a very good feedhorn with less than 1 dB feedline loss for the additional length.

A sketch of this example in Figure 24 illustrates the geometry, with the feed quite close to the subreflector. However, actually making this antenna requires a final tradeoff: my lathe has a maximum capacity of 9 inches, or 7.9λ at 10 GHz. The 14.3λ subreflector is over 16 inches in diameter, too large to turn on my lathe. With a smaller subreflector, I would have a small amount of feedhorn blockage plus some loss from having the subreflector in the near field of the feed. My guess is that the end result wouldn't be a lot worse.

How about a really deep dish? Edmunds Scientific²¹ sells parabolic reflectors for solar heating with an $f/D = 0.25$. These have a polished surface which appears to be nearly optical quality, so they might be good for higher bands, but I haven't measured one. Assuming that the surface is good enough for 47 GHz, how well would an 18-inch version work as a Cassegrain antenna?

A good feed which is easy to make is the W2IMU dual-mode horn, which best illuminates an f/D around 0.6. The spreadsheet in Figure 25 shows that this combination requires an illumination taper of 12.46 dB and a minimum subreflector diameter of 5.96λ . However, to keep the subreflector out of the near field of the feedhorn requires a larger subreflector, 7.7λ in diameter. The calculated subreflector efficiency is still high, 86%, or less than 0.7 dB loss. At 47 GHz, that's hard to beat. When we multiply the subreflector efficiency by the calculated feedhorn efficiency, 69% at the effective f/D of 0.7, the net efficiency is about 59%. The geometry is sketched in Figure 26.

The larger 7.7λ subreflector is still only 49mm in diameter, quite manageable on a small lathe. This combination looks worth a try.

Figure 25

CASSEGRAIN ANTENNA DESIGN CALCULATOR

W1GHZ 2004

ENTER INPUT PARAMETERS HERE:

(Bold blue numbers)

Frequency

47.100

GHz

pi = 3.141593

Units:

mmInchesWavelengths

Dish diameter

457

18.0

71.7

Dish f/D

0.25

Feedhorn equivalent f/D

0.6

Feedhorn diameter

8.4

0.331

1.3188**Warning: feedhorn diameter too small for f/D**

Feedhorn Phase Center (negative = inside horn)

0**Wavelength****6.369**

0.251

1

Dish Focal Length

114.3

4.5

17.9

Dish Illumination halfangle

90.0 degrees

1.571 radians

Feedhorn illumination halfangle

45.2 degrees

0.790 radians

Redge (prime focus to rim)

228.5

9.0

35.9

Space attenuation for main dish

6.02 dB

Space attenuation for virtual dish

1.39 dB

Decision point:**Suggested illumination taper = 12.46 dB****Enter desired illumination taper : 12.46 dB****With desired taper:**

Feedhorn illumination halfangle

39.1 degrees

0.683 radians

Feedhorn equivalent f/D

0.70

Minimum subreflector diameter

38.0

1.494

5.96

Subreflector focal length

23.3

0.918

3.66

Subreflector f/D

0.61

d_sub/D_main

0.08

Maximum subreflector efficiency (Diffraction loss = blockage loss)

87.8%

Feedhorn blockage halfangle

10.2 degrees

0.178 radians

Estimated Minimum feedhorn blockage angle

10.9 degrees

0.190 radians

Without feedhorn blockage -- increase subreflector diameter to eliminate feedhorn blockage:

Minimum subreflector diameter

39.5

1.556

6.20**Using estimated minimum feedhorn**

Subreflector focal length

24.3

0.956

3.81

d_sub/D_main

0.09

Subreflector efficiency (Diffraction plus blockage losses)

86.9%

Feedhorn blockage halfangle

9.8 degrees

0.171 radians

Decision point:**Enter desired subreflector diameter : 7.7 in wavelengths****or go back and change feedhorn****With desired subreflector diameter:**

Subreflector focal length

30.1

1.187

4.73

d_sub/D_main

0.11

Subreflector efficiency (only blockage loss increases)

86.2%**Cassegrain loss = -0.644 dB****For overall efficiency, find efficiency on feedhorn PHASEPAT curve for f/D= 0.70****and multiply by 0.862**

CASSEGRAIN SUBREFLECTOR GEOMETRY:

Feedhorn blockage halfangle				7.9	degrees	0.138 radians
Subreflector magnification M				2.81		
Hyperbola eccentricity				2.10		
Hyperbola a	7.2	0.282	1.13			
Hyperbola b	13.3	0.522	2.08			
Hyperbola c	15.1	0.593	2.37			

SUBREFLECTOR POSITION:

Apex to Dish focal point	7.9	0.311	1.24
Apex to Feed Phase Center	22.2	0.876	3.49

Feedhorn Rayleigh distance = 3.48

Background calculations:

Optimum illumination taper for Cassegrain, from Kildal
from curve fitting 12.45952384

Optimum subreflector size, from Kildal (Diffraction loss = blockage loss)

E (voltage taper)	0.056754461
term 1	0.006332574
term 2	0.788341679
term 3	0.000791014
dsub over Dish diameter	0.083041614

Maximum Cassegrain efficiency for optimum d/D, from Kildal

ds_ratio	0.083041614
Cb	1.883132863
term 4	9.096130123
maximum efficiency	0.87848238
max_eff	0.87848238

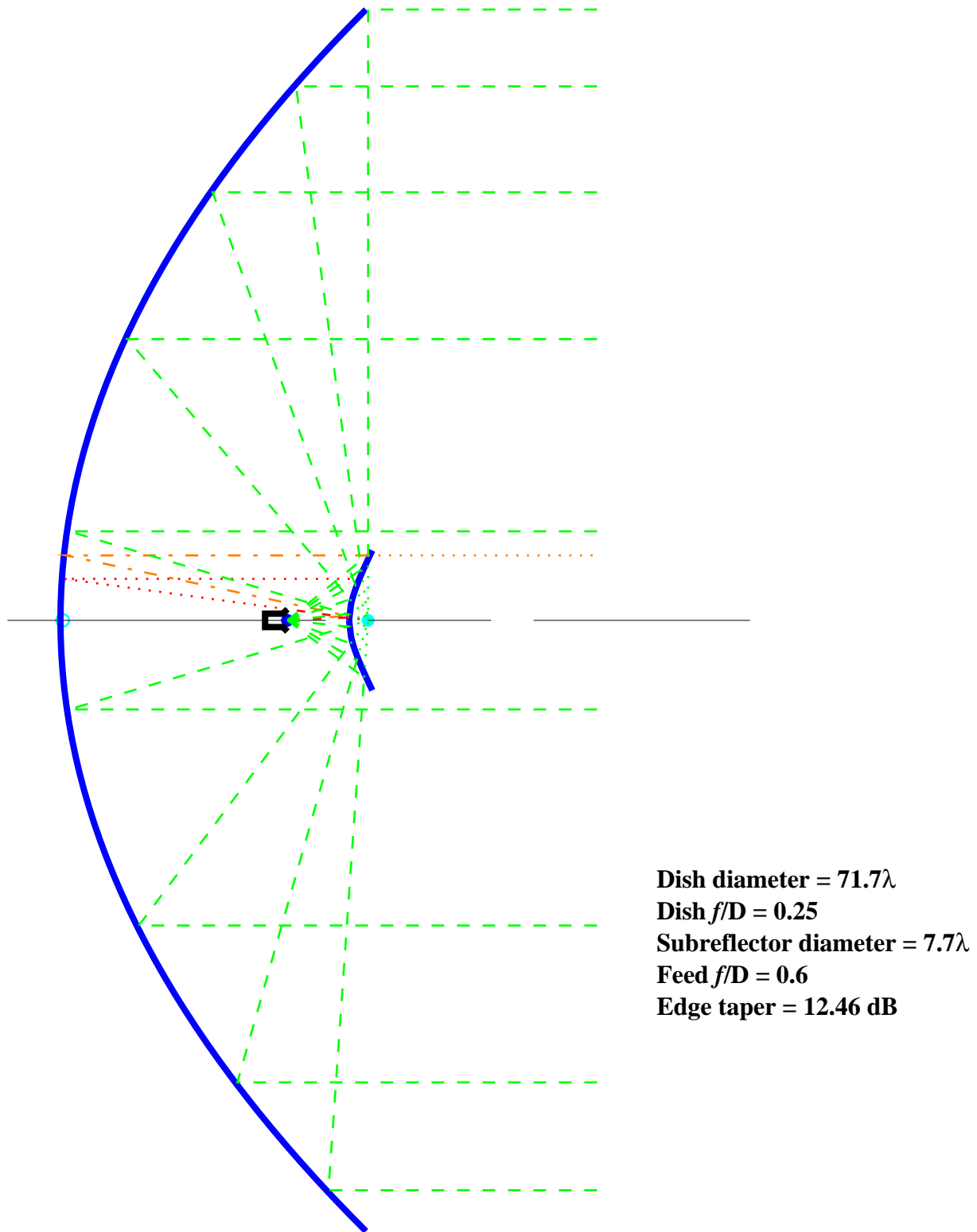
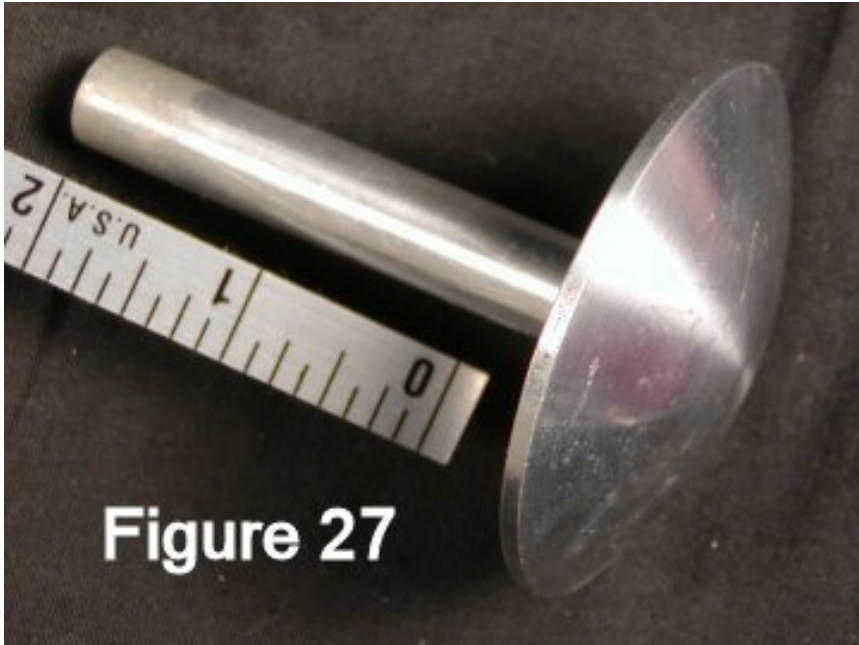

Figure 26. Cassegrain example: 18" Edmunds dish at 47 GHz

Reverse-engineering a Cassegrain subreflector



At the 2003 Eastern VHF/UHF Conference, several small subreflectors were auctioned. I won the bid for one, shown in Figure 27 — now what is it good for?

The first step is to measure the profile. Using a dial indicator and a digital caliper, as shown in Figure 28, I measured a number of points along the surface, with an estimated

accuracy of 0.005 inch (inexpensive instruments in the USA read in inches), or about 0.1 mm. Then I used **MATLAB**²² to fit the points to the hyperbolic equation above. The curve-fitting was pretty good: the total mean-square error for 30 points was about 0.009 inch, so the average error is less than 1 mil. With that kind of accuracy, this subreflector may be good to over 100 GHz. The best-fit parameters after correcting for the dial indicator tip diameter were:

$$a = 2.159 \text{ inch}$$

$$b = 1.984 \text{ inch}$$



From these two parameters, we can calculate everything else:

$$c = \sqrt{a^2 + b^2} = 2.932 \text{ inch}$$

$$f_{\text{hyp}} = 2c = 5.864 \text{ inch}$$

$$e = \frac{c}{a} = 1.358$$

$$M = \frac{e + 1}{e - 1} = 6.585$$

Since the subreflector is 2.56 inches or 65 mm in diameter, we know that

$$f_{\text{hyp}} / d_{\text{sub}} = 2.3$$

And we know the magnification factor, M , of the subreflector:

$$M = \frac{f_{\text{hyp}} / d_{\text{sub}}}{f_{\text{p}} / D_{\text{p}}}, \text{ so this subreflector is best suited for a parabola with:}$$

$$f_{\text{p}} / D_{\text{p}} = \frac{1}{M} \cdot f_{\text{hyp}} / d_{\text{sub}} = 0.35$$

without any correction for illumination taper. It would probably work quite well for any f/D between 0.3 and 0.4.

The subreflector diameter is 10λ at 47 GHz, so it should work well feeding a dish of 0.5 meter or larger diameter. Note that a rather large feedhorn is required to since

$$f_{\text{hyp}} / d_{\text{sub}} = 2.3; \text{ thus, the illumination half-angle is only } 12^\circ. \text{ Plugging these numbers into}$$

the spreadsheet yields about 84% subreflector efficiency for a 500mm dish. The subreflector is in the near field of the feedhorn, so there may be a small additional loss due to phase error.

Gregorian Antenna Design

The design procedure for a Gregorian antenna with an elliptic subreflector, sketched in Figure 29, is similar to the Cassegrain procedure above. Milligan¹⁵ points out that the resulting subreflector will be slightly larger. We will not go through the entire procedure again, since all the first six steps are the same. Starting with step 7, the difference is the elliptical subreflector parameters:

$$M = \frac{\text{effective feed } f/D}{f_p/D_p}, \text{ the Magnification factor, is the same as the Cassegrain.}$$

The eccentricity

$$e = \frac{M - 1}{M + 1} \text{ is less than one, while it is greater than one for a hyperbola.}$$

The focal length of the ellipse is

$$f_{\text{ell}} = 0.5 \cdot d_{\text{sub}} \cdot (\cot(\psi') - \cot(\phi))$$

Then the parameters of the ellipse (see sketch in Table 1) are:

$$c = \frac{f_{\text{ell}}}{2}$$

$$a = \frac{c}{e}$$

$$b = \sqrt{a^2 - c^2}$$

The distance from the apex of the subreflector to the virtual focus (the focus of the main parabola) behind the subreflector is a-c.

The distance from the apex of the subreflector to the phase center of the feedhorn is c+a.

A larger subreflector increases blockage. However, our small dish examples with the Cassegrain configuration needed a larger subreflector so it was not in the near field of the feed. Since the Gregorian subreflector is beyond the prime focus, it is naturally farther from the feed. So it is hard to say which is better for small dishes without working out actual numbers. If I were thinking of turning a subreflector on a lathe, the hyperbola seems a bit easier.

There are two points worth noting about the Gregorian antenna. The first is that the top half of the subreflector illuminates the bottom half of the dish, and vice-versa. The other is that all the rays cross come to a point at the prime focus – this would mean that all the power is concentrated in a very small space, so the power density approaches infinity, and various laws

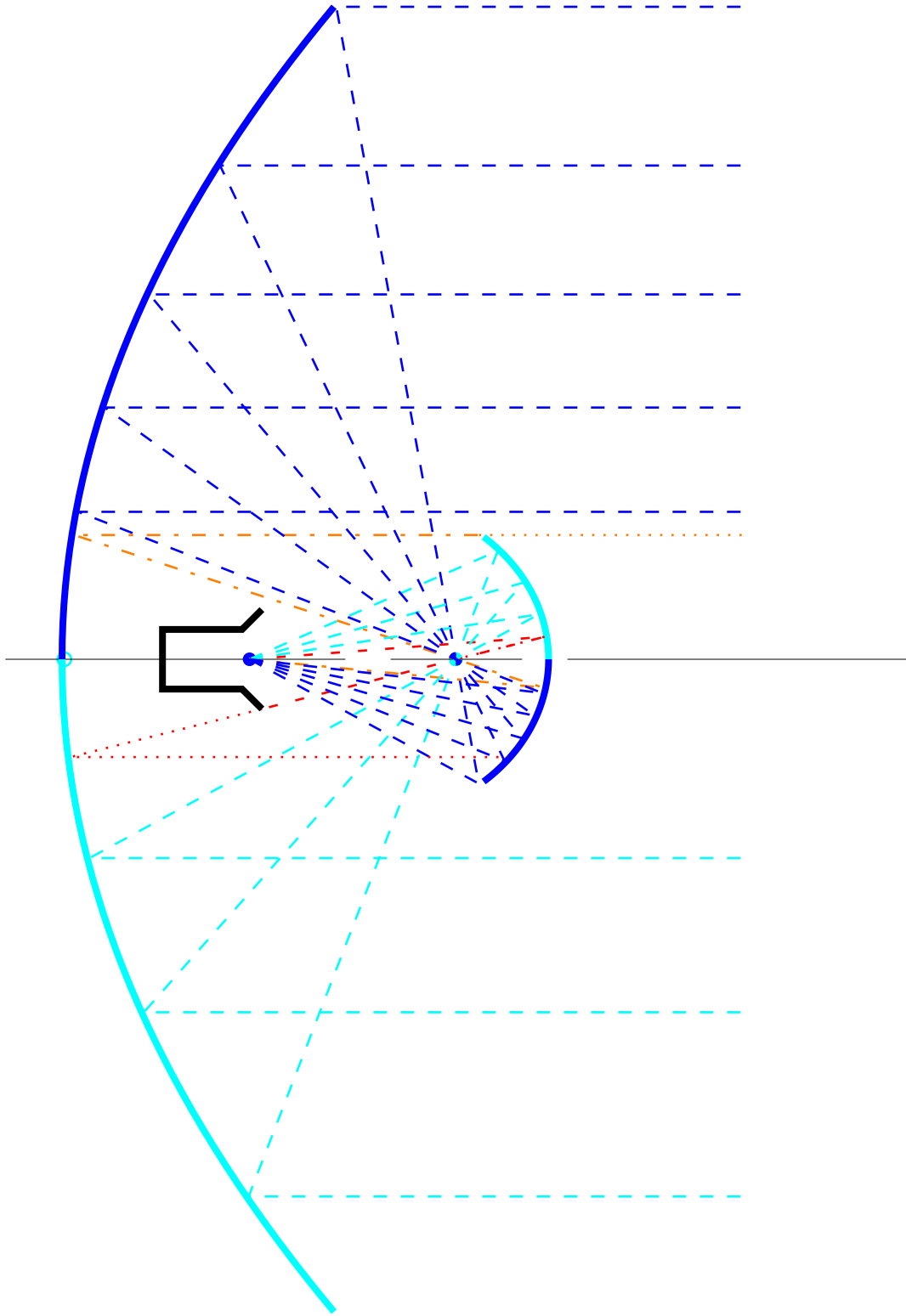

Figure 29. Gregorian antenna

of physics would be violated. Pierce²³ shows that the waves crowd into a diameter of about 0.6λ and spread out again. It is probably not a coincidence that this is also the minimum diameter for waveguide propagation.

Summary: Cassegrain and Gregorian Antennas

Before we move on to more esoteric multiple-reflector antennas, we should consider the advantages and disadvantages of the Cassegrain and Gregorian antennas. Then any advantage provided by other types will be more apparent.

Advantages include:

- Feed pattern reshaping, allowing use of efficient feedhorns
- Convenient feed location with shorter feedline
- Better illumination of very deep dishes
- At high elevations, little spillover toward ground – all sidelobes point at cold sky (*KIJT pointed out at EME2004 that this is the most important feature for radio astronomers*)
- Large depth of focus
- A more compact structure

Disadvantages include:

- Greater blockage, particularly with small dishes
- Higher sidelobes (blockage increases sidelobes)
- Larger feedhorns
- Not good with broadband feeds
- Tighter tolerance requirements

The tighter tolerance requirement is needed to keep all path lengths equal. The tolerance required for the reflector surface of a prime focus dish is a small fraction of a wavelength, typically $1/10\lambda$ or $1/16\lambda$; references vary. Jensen¹⁴ shows a curve with one dB loss for an RMS tolerance of $1/25\lambda$, or just over 1 mm at 10 GHz. Note that RMS tolerance is averaging whole surface; larger errors over small parts of a dish are not fatal.

The important point is that for the Cassegrain and Gregorian configurations, the same tolerance is required for the sum of the parabolic reflector surface, the subreflector surface, and the subreflector positioning. Each ray path must have the same length \pm tolerance.

The feed position tolerance, or depth of focus, is less critical. The magnification factor **M** that reshapes the illumination angle makes the feed position less critical by the same ratio. Thus, if we were to adjust a Cassegrain feed while measuring sun noise, we would keep the feedhorn fixed in one location, since the feed position is not critical, and vary the more critical subreflector position.

Offset Cassegrain and Gregorian Antennas

Just as an offset-fed parabola has the advantage of reduced feed blockage, Cassegrain and Gregorian antennas can use an offset configuration to reduce or eliminate subreflector and feed blockage.

Most of the offset parabolas we see, like the DSS dishes, include the vertex of the full parabola. A sketch in Figure 31 of half of a Cassegrain antenna, from the vertex up, shows that these dishes would still suffer subreflector blockage in an offset Cassegrain configuration. The useful portion of the parabola for this configuration is further out, toward the rim, so the antenna is best designed from scratch as a complete system. Granet²⁴ provides a detailed design procedure if you are so inclined.

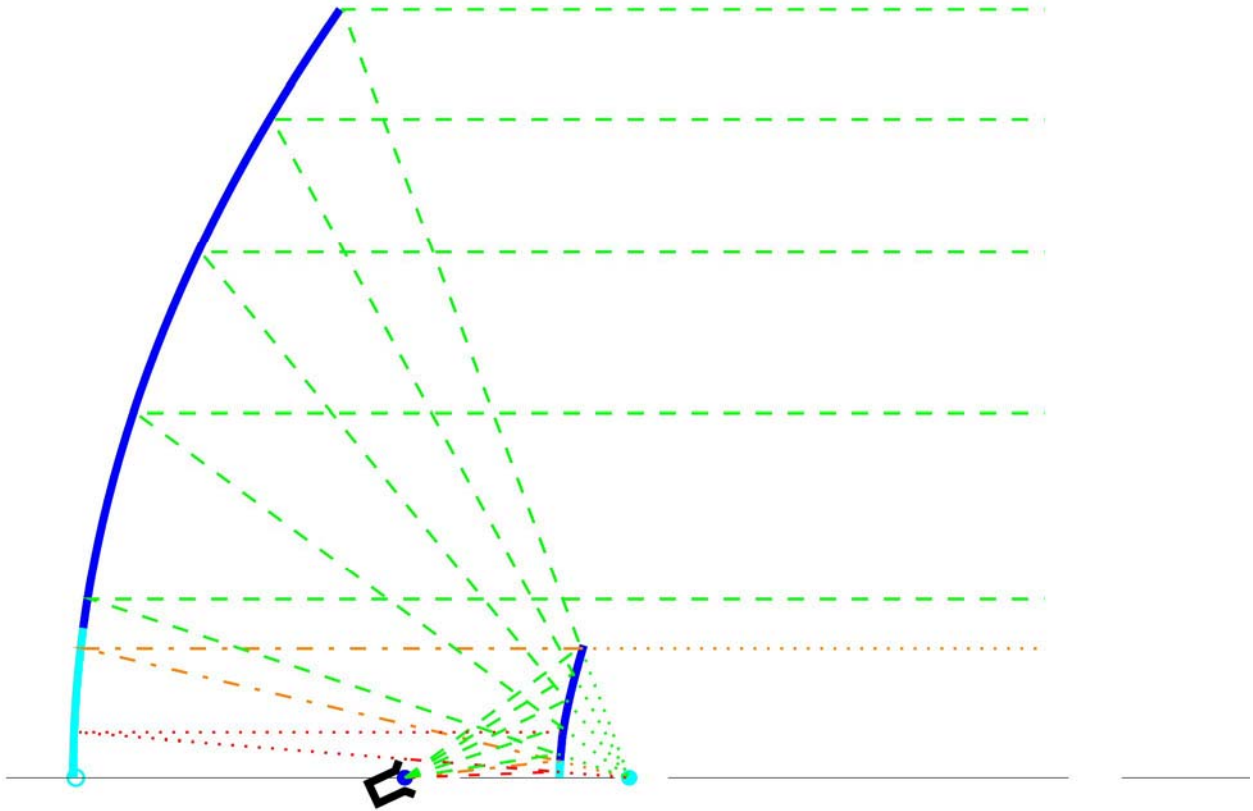

Figure 31. Offset Cassegrain Antenna

The offset Cassegrain has one advantage that makes it popular for certain applications: the ability to reduce cross-polarization. Reflection from a curved reflector induces cross-polarization at certain angles. In the offset Cassegrain, cross-polarization from the subreflector tends to cancel cross-polarization induced by the main reflector. With the right combination²⁵ of parameters and angles, cross-polarization may be reduced to an extremely low level.

The Gregorian configuration is more suitable for DSS offset dishes, since one side of the elliptical subreflector illuminates the opposite side of the main reflector, as shown in the sketch in Figure 32. Thus, there is no subreflector blockage anywhere above the vertex. Granet also covers this configuration.

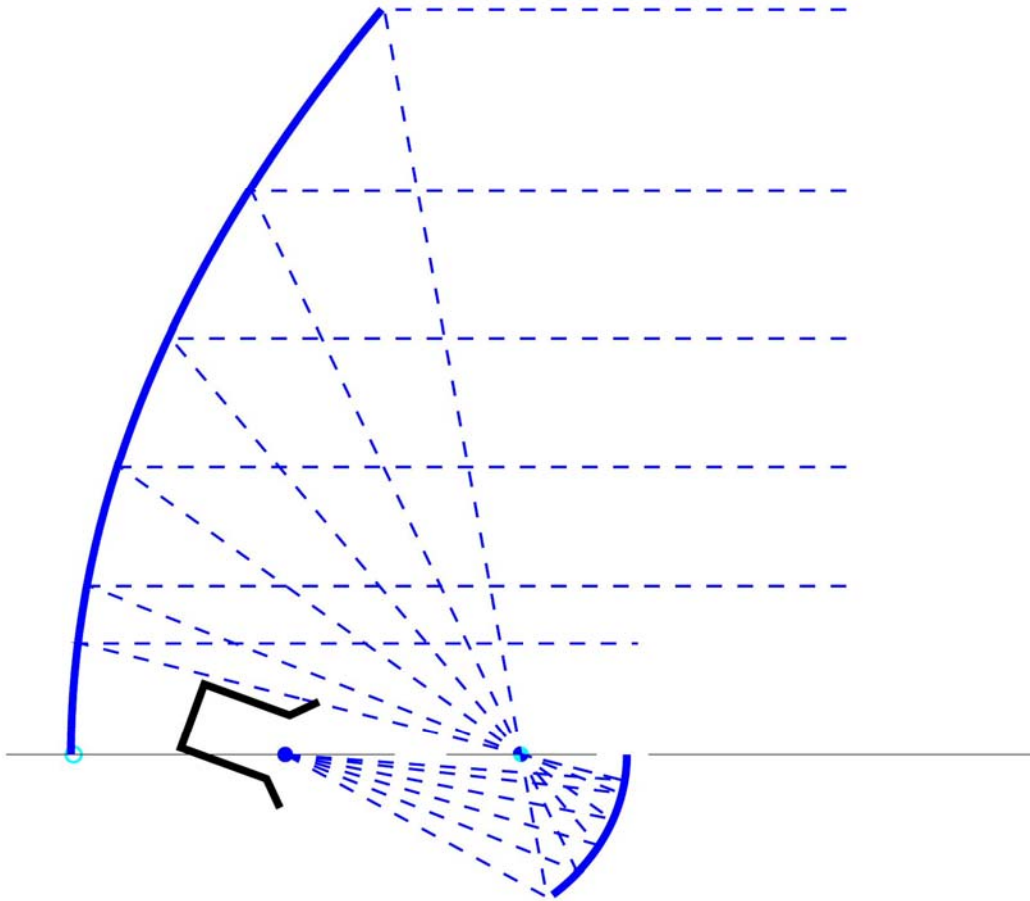

Figure 32. Offset Gregorian antenna

With either offset configuration, if the subreflector position causes no blockage, then the subreflector can be large enough to minimize diffraction loss as well as spillover. Thus, three of the major loss factors are removed, so the potential efficiency can be much higher.

For an example, G3PHO provided the photograph of an offset DSS dish with a subreflector in Figure 33. We are still working on reverse-engineering the details.



ADE Antenna

A clever extension of the offset Gregorian is the ADE, Axially Displaced Ellipse, described by Rotman and Lee²⁶. Starting from the Gregorian antenna sketch in Figure 29, the two halves of the cross section, shown as light and dark halves, are separated by the subreflector diameter in Figure 34. Since the subreflector halves follow the opposite sides of the parabola, the subreflector is turned inside out while maintaining the elliptical curve, so that it comes to a point in the center.

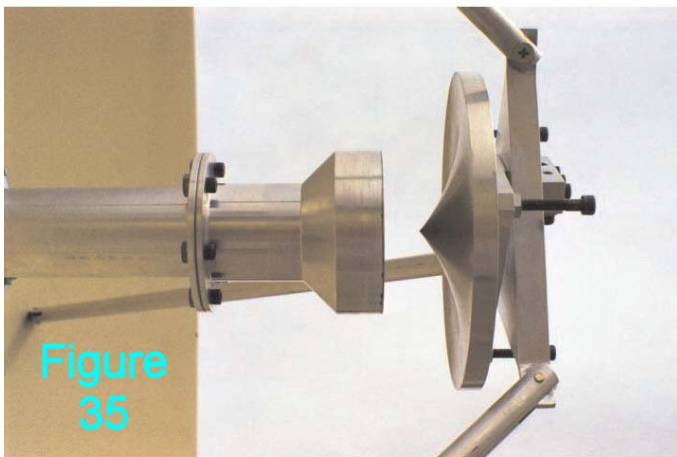

Understanding this antenna in three dimensions takes a bit of imagination, rotating the sketch around the axially line. One half of the parabolic curve is rotated not around an axial line at the vertex, but rather with the vertex traveling in a ring around a cylinder with the same diameter as the subreflector. The focus is also a ring, rather than a point, separated from the vertex ring by the focal length of the parabola. Thus, the parabola is axially displaced, leaving a hole in the center,

not part of the parabolic curve, for the feed. The subreflector only shadows the hole, so there is no blockage from either the feedhorn or subreflector. Figure 35 is a photo of the subreflector of an ADE antenna^{27, 28}.

The other advantage of the ADE system may be seen in Figure 34 — the rays from the center of the feedhorn, where intensity is maximum, are reflected by the subreflector to the edge of the dish, while the edges of the feed beam are reflected to the center of the dish. The resulting dish illumination is more uniform than the normal taper, so the efficiency can be very high.

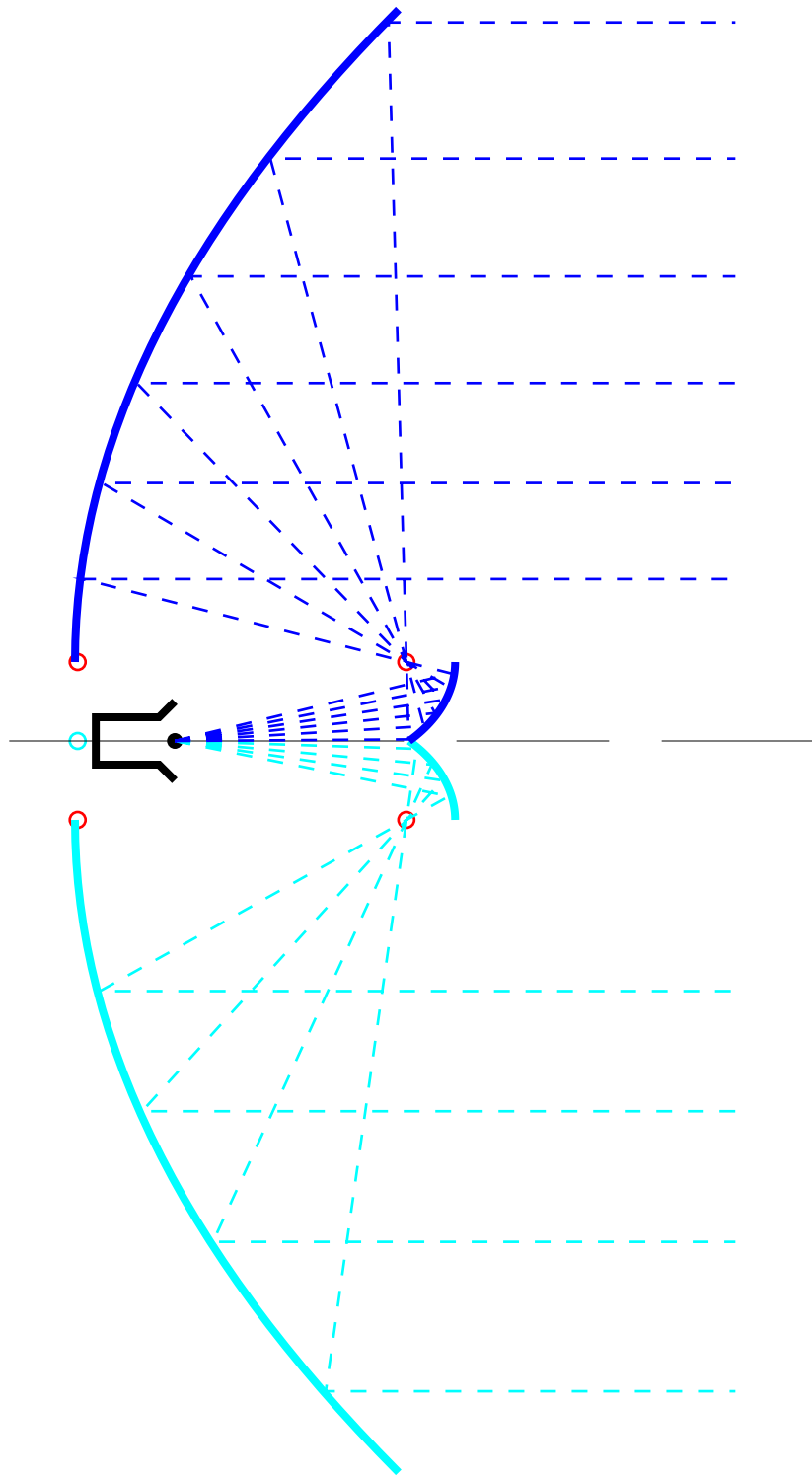
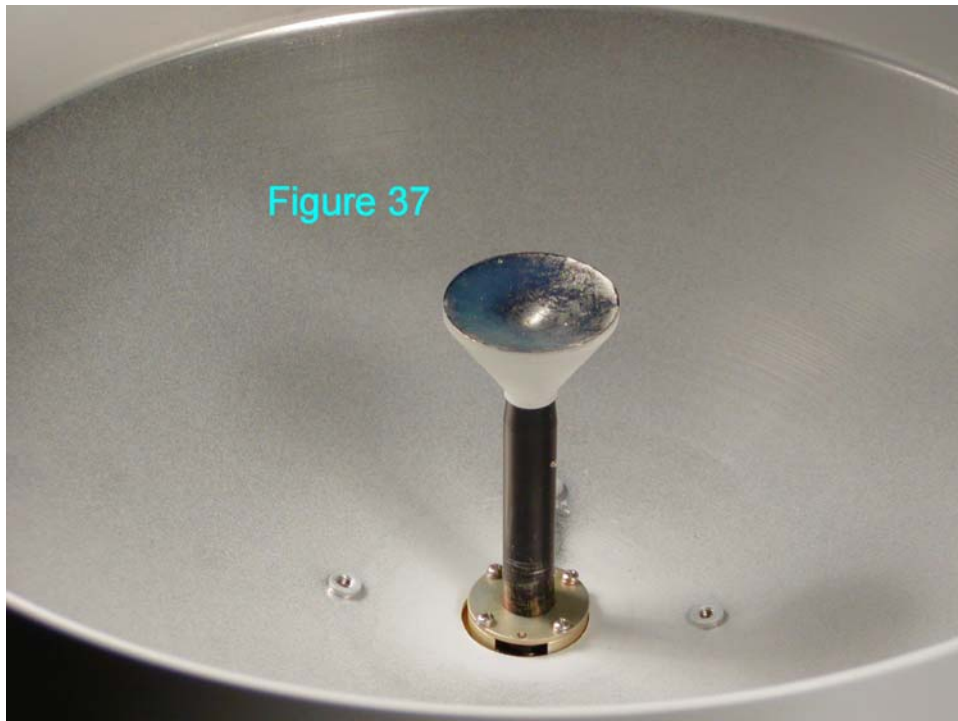

Figure 34. ADE (Axially-Displaced Ellipse) Antenna

Dielguide Antenna

Another variation, this time of the Cassegrain antenna, is the Dielguide antenna^{29, 30}. A dielectric cone fills the space between the feed and the subreflector. The subreflector shape may be molded or turned into the end of the dielectric, then plated or covered with foil to form the reflecting surface. Since the dielectric fixes the subreflector position, no other support is required, so blockage is minimized. The feed illumination travels inside the dielectric, and potential spillover is reflected back to the subreflector if the cone angle is less than the critical angle for total internal reflection — for a good dielectric like Rexolite, a feed f/D greater than 0.7 satisfies this condition.

The Dielguide antenna is sketched in Figure 36. Each incoming ray focused by the parabola is reflected from the subreflector, then subject to refraction at the interface between dielectric and air. The refracted rays no longer arrive at a point at the prime focus of the parabola, but are spread out and closer to the dish. Since the rays must all appear to radiate from the prime focus of the parabola for the dish to work, the subreflector must be reshaped. All rays must also have equal electrical path lengths, including slower propagation in the dielectric. The subreflector shape and location must meet all these conditions simultaneously, making design of the subreflector even more challenging.



A version of the dielguide antenna has been made available to hams by NW1B³¹. Figure 37 is a photo of a 340mm version for 24 GHz.

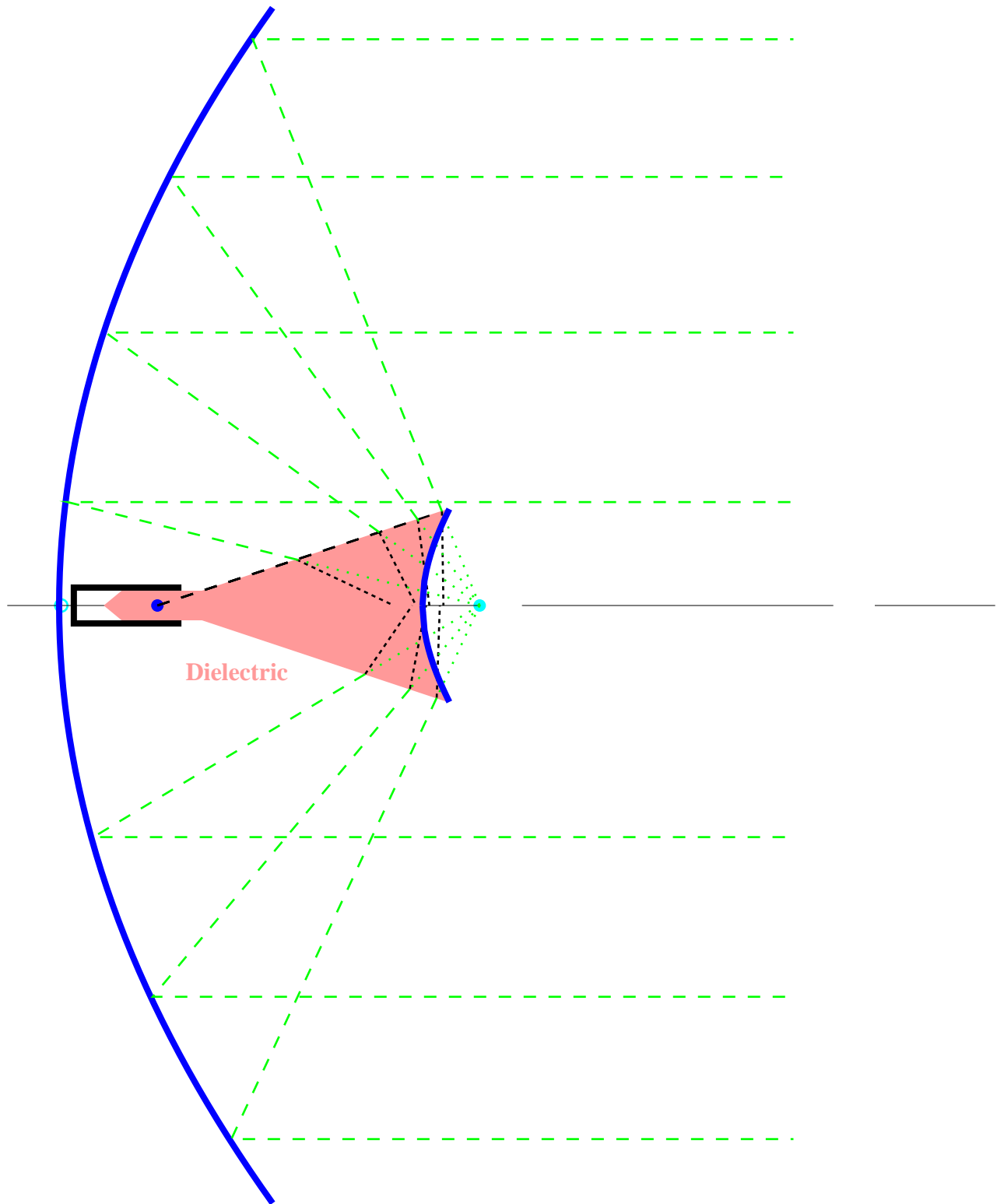

Figure 36. Dielectric Antenna Sketch showing Refraction

Shaped Reflector Antenna

One of the advantages of the multiple-reflector antenna is the ability to reshape the feed illumination. The shaped reflector^{32, 33} takes this further, calculating a subreflector shape to provide optimum illumination to the main reflector. Since all rays must still have identical path lengths, the main reflector must also be reshaped to compensate, so neither reflector is a conic section. Now many solutions are possible, with the opportunity to spend lots of computer time on optimization.

The shaped reflector can provide significantly increased efficiency. However, the reflector shaping creates unequal ray spacing which causes poor imaging³⁴, a potential problem in radio astronomy, but not for communications.

Beam Waveguide Antenna

The ultimate multiple reflector antenna is the beam waveguide antenna, where the feedline is replaced by a series of focusing reflectors guiding the beam from the underground source to the dish. Figure 38 is a sketch of the JPL³⁵ beam waveguide system. Since each reflector must be large enough for diffraction loss to be small, this is only feasible for a very large dish, like the 34-meter Goldstone³⁶ antenna at X-band. The photos in Figure 39 give some idea of the size of the dish and of two of the underground focusing reflectors. Each reflector appears to be quite large, many wavelengths in diameter to avoid diffraction effects.

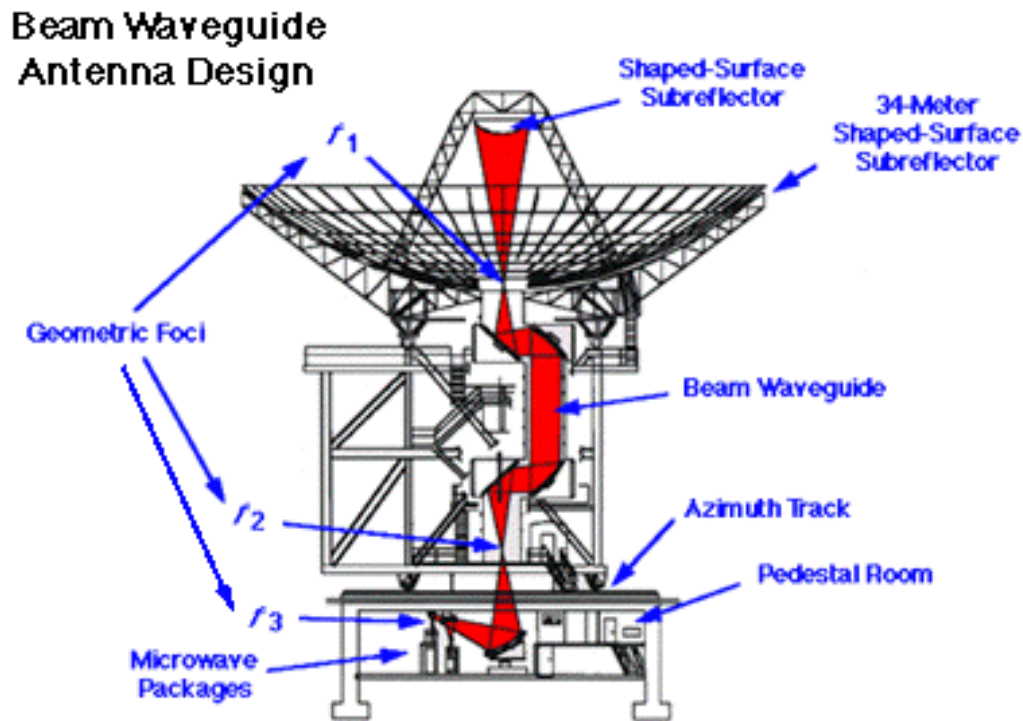

Figure 38

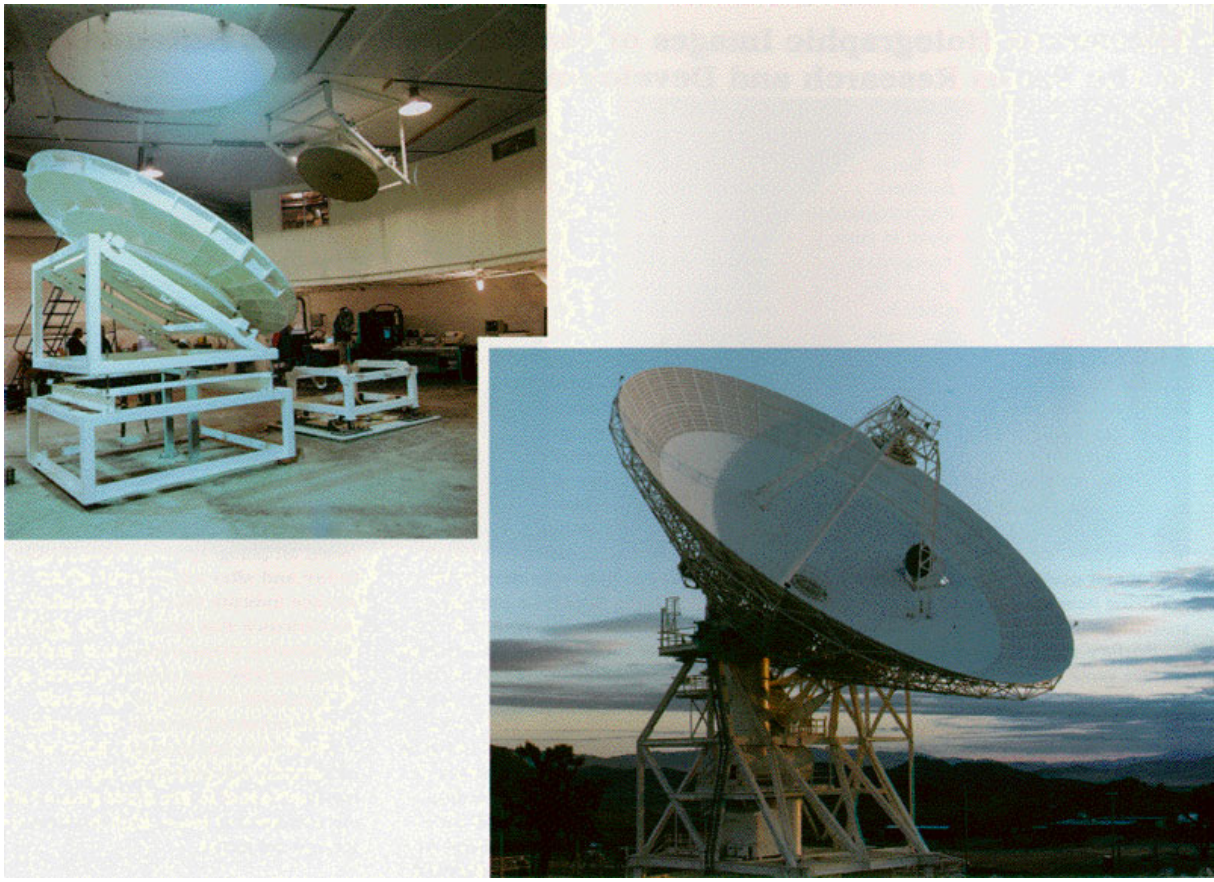

Figure 39

Measured efficiency³⁷ is outstanding, 71% at 8.4 GHz and 57% at 32 GHz, including the entire beam waveguide to the underground equipment.

Conclusion

Multiple-reflector antennas have the potential to provide higher performance, particularly for large, deep dishes. This is especially true at the higher microwave frequencies, where the choices for suitable dishes are limited, and feedline losses quickly become intolerable.

We have described a design procedure for Cassegrain and Gregorian antennas which includes performance estimates so that informed tradeoffs may be made. For smaller dishes, the performance benefits are also small, so it is important to evaluate tradeoffs. In some cases, the additional complexity of a multiple-reflector antenna may not be justified.

More esoteric types are less likely to be designed by hams, but descriptions and references should be enough to allow the surplus scrounger to understand and utilize his lucky find.

References:

1. <http://www.kolumbus.fi/michael.fletcher/>
2. <http://www.andrews.edu/~calkins/math/webtexts/numb19.htm>
3. <http://www.tivas.org.uk/socsite/scopes.html>
4. Ovidio M. Bucci, Giuseppe Pelosi, Stefano Selleri, "Cassegrain?," *IEEE Antennas and Propagation Magazine*, June 1999, pp. 7-13.
5. <http://www.celestron.com/tb-2ref.htm>
6. P. W. Hannon, "Microwave Antennas Derived from the Cassegrain Telescope," *IRE Transactions on Antennas and Propagation*, March 1961, pp. 140-153.
7. Donald C. O'Shea, *Elements of Modern Optical Design*, Wiley, 1985.
8. <http://sol.sci.uop.edu/~jfalward/refraction/refraction.html>
9. R.H. Clarke and John Brown, *Diffraction Theory and Antennas*, Ellis Horwood, 1980, p. 11.
10. Per-Simon Kildal, *Foundations of Antennas — A Unified Approach*, Studentlitteratur, 2000, p. 10.
11. Joseph B. Keller, "Geometrical Theory of Diffraction," *Journal Optical Society of America*, February 1962, pp. 116-130.
12. John Kraus [W8JK], *Antennas*, McGraw-Hill, 1950, pp. 361-364.
13. Martin Farmer, G7RMF, "Large Dish Cassegrain Development Using CAD & Spreadsheet For Millimetric Bands & Practical Implementation," <http://www.qsl.net/g3pho/casseg.pdf>
14. P.A. Jensen, "Cassegrain Systems," in A.W. Rudge, K. Milne, A.D. Olver, P. Knight (editors), *The handbook of Antenna Design*, Peter Peregrinus, 1986, pp. 162-183.
15. Thomas Milligan, *Modern Antenna Design*, McGraw-Hill, 1985, pp. 239-249.
16. Per-Simon Kildal, "The Effects of Subreflector Diffraction on the Aperture Efficiency of a Conventional Cassegrain Antenna — An Analytical Approach," *IEEE Transactions on Antennas and Propagation*, November 1983, pp. 903-909.
17. Christophe Granet, "Designing Axially Symmetric Cassegrain or Gregorian Dual-Reflector Antennas from Combinations of Prescribed Geometric Parameters," *IEEE Antennas and Propagation Magazine*, April 1998, pp. 76-82.
18. www.w1ghz.org
19. Christophe Granet, "Designing Axially Symmetric Cassegrain or Gregorian Dual-Reflector Antennas from Combinations of Prescribed Geometric Parameters, Part 2: Minimum Blockage Condition While Taking into Account the Phase Center of the Feed," *IEEE Antennas and Propagation Magazine*, June 1998, pp. 82-85.
20. P.J. Wood, *Reflector antenna analysis and design*, Peter Peregrinus, 1980, pp. 156-157.

21. www.edmundoptics.com
22. www.mathworks.com
23. John R. Pierce, *Almost All About Waves*, MIT Press, 1974, pp. 170-173.
24. Christophe Granet, "Designing Classical Offset Cassegrain or Gregorian Dual-Reflector Antennas from Combinations of Prescribed Geometric Parameters," *IEEE Antennas and Propagation Magazine*, June 2002, pp. 114-123.
25. Ta_Shing Chu, "Polarization Properties of Offset Dual-Reflector Antennas," *IEEE Transactions on Antennas and Propagation*, December 1991, pp. 1753-1756.
26. Walter Rotman and Joseph C. Lee, "Compact Dual Frequency Reflector Antennas for EHF Mobile Satellite Communication Terminals," *1984 IEEE International Antennas & Propagation Symposium Digest*, pp. 771-774.
27. Aluizio Prata, Jr., Fernando J.S. Moreira, and Luis R. Amaro, "Displaced-Axis-Ellipse Reflector Antenna for Spacecraft Communications," <http://www.cpdee.ufmg.br/~fernando/artigos/imoc03a.pdf>
28. Aluizio Prata, Jr., Fernando J.S. Moreira, and Luis R. Amaro, "Compact High-Efficiency Displaced-Axis Axially Symmetric High-Gain Antenna for Spacecraft Communications," *JPL IND Technology and Science News* May 2003, pp. 9-14. <http://www.cpdee.ufmg.br/~fernando/artigos/IND2003.pdf>
29. H.E. Bartlett and R.E. Moseley, "Dielectric Guides — highly efficient low noise antenna feeds," *Microwave Journal*, September 1966, pp. 53-58.
30. P.J.B. Clarricoats, C.E.R.C. Salema, S.H. Lim, "Design of Cassegrain Antennas Employing Dielectric Cone Feeds," *Electronic Letters*, July 27, 1972, pp. 384-385.
31. <http://mysite.verizon.net/vze1on0x/index.html>
32. Victor Galindo, "Design of Dual-Reflector Antennas with Arbitrary Phase and Amplitude Distributions," *IEEE Transactions on Antennas and Propagation*, July 1964, pp. 403-408.
33. William F. Williams, "High Efficiency Antenna Reflector," *Microwave Journal*, July 1965, pp. 79-82.
34. Rachael Padman, "Optical Fundamentals for Array Feeds," in Darrel T. Emerson and John M. Payne, editors, *Multi-Feed Systems for Radio Telescopes*, Astronomical Society of the Pacific, 1995, pp. 3-26.
35. Figures 38 and 39 Courtesy NASA/JPL-Caltech, <http://deepspace.jpl.nasa.gov/dsn/antennas/34m.html#BWG>
36. T. Veruttipong, J. R. Withington, V. Galindo-Israel, W. A. Imbriale, and D. A. Bathker, "Design considerations for beamwaveguide in the NASA Deep Space Network," *IEEE Transactions on Antennas and Propagation*, December 1988, pp. 1779-1787.
37. David D. Morabito, "The characterization of a 34-meter beam-waveguide antenna at Ka band (32.0 GHz) and X band (8.4 GHz)," *IEEE Antennas and Propagation Magazine*, August 1999, pp. 23-34.