

SECTION 5

NEUTRALIZATION

A completely neutralized amplifier must fulfill two conditions. The first is that the interelectrode capacitance between the input and output circuits be cancelled. The second requirement is that the inductance of the screen grid and cathode assemblies and leads be completely cancelled. Cancellation of these common impedances between the input and output will theoretically prevent oscillation. This also applies in practice, but often not without some difficulty.

There are a variety of methods of accomplishing these ends that will fulfill the two conditions. At frequencies up to about 500 KHz it is not normally necessary to neutralize a grid-driven triode. A grounded-grid cathode-driven triode can usually be operated up into the VHF range without neutralization. Tetrode and pentode amplifiers generally will operate into the HF range without neutralization. As the gain of the amplifier increases, the need to cancel feedback voltage becomes that much more necessary. For this reason, it is usually necessary to neutralize tetrodes and pentodes at the higher frequencies.

5.1 NEUTRALIZATION BELOW VHF

At frequencies below the VHF region, neutralization usually employs a capacitance bridge circuit to balance out the feedback due to the residual plate-to-grid capacitance. This assumes that the screen is well by-passed to ground and so provides the expected screening action. In the VHF and UHF regions the screen is not necessarily at r-f ground potential. The neutralizing circuit, therefore, becomes more involved.

If neutralization on the fundamental frequency below the VHF region is found desirable, normal cross-neutralization of push-pull amplifiers is simplest. The neutralizing capacitors are small. In the case of triodes, special neutralization capacitors are manufactured and are available as catalog items.

In the case of the small tetrode or pentode each capacitor need only be a wire connected to each side of the grid circuit, brought through the chassis deck, and allowed to "look" at the plate of the tube on the opposite half of the circuit. This is illustrated in Figure 57.

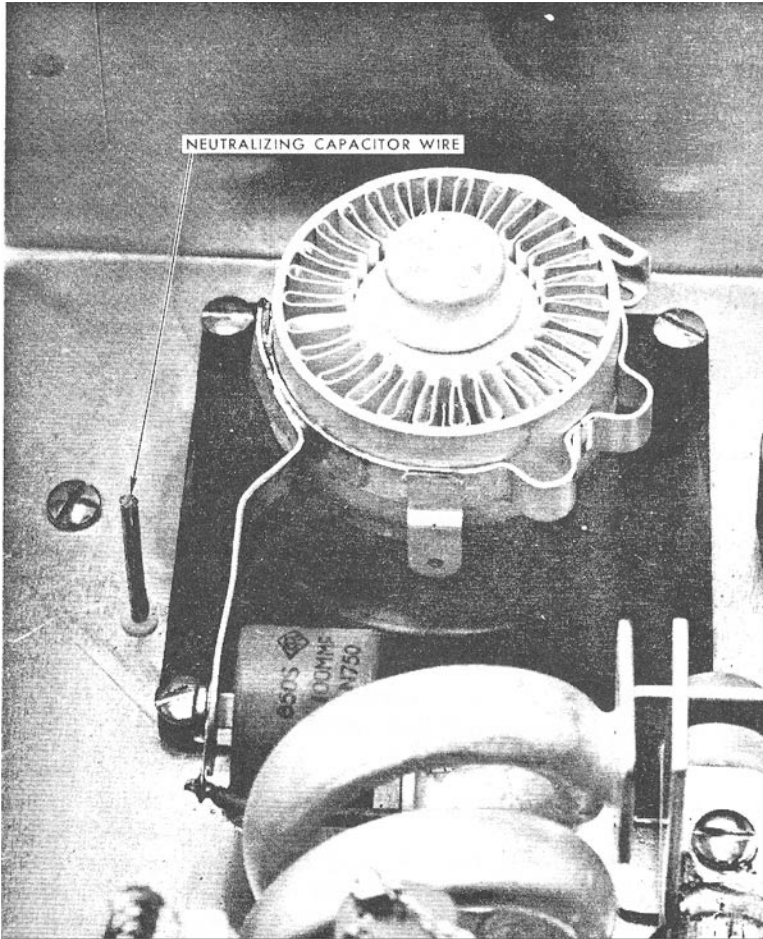

Figure 57. Wire neutralizing system.

The wire or rod can be one-half to one inch away from the tube; by adjusting its length or spacing the last trace of coupling can be eliminated from the amplifier. A simple insulating collet mounted on the chassis deck will support the wire or rod and allow it to be adjusted.

5.2 PUSH-PULL NEUTRALIZATION

In the case of a single-ended stage, either a push-pull output or a push-pull input circuit can be used to provide the out-of-phase voltage necessary for neutralization. Because of the lower voltage and the smaller size of the r-f input circuit, it is usually simpler to make the input circuit push-pull and the circuit becomes a "grid-neutralization" circuit (see Figure 58). The neutralizing capacitor, C_n , is small and similar to those described above under cross-neutralization. To maintain the balance of the input circuit while tuning, it is desirable to have a padding capacitor, C_1 , equal in size to the input capacitance of the tube.

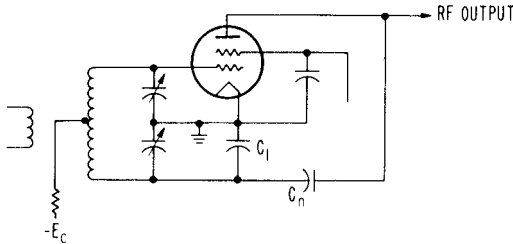

Figure 58. Push-pull grid neutralization, basic circuit.

5.3 SINGLE-ENDED NEUTRALIZATION

Single-ended tetrode and pentode r-f amplifier stages can also be grid-neutralized without using a conventional push-pull input circuit (see Figure 59). In this method, the input resonant circuit is taken off ground a small amount by making the input circuit by-pass capacitor, C , somewhat smaller than usual. The voltage to ground across the capacitor, C , is out of phase with the grid voltage and can be fed back to the plate to provide neutralization. In this case the neutralizing

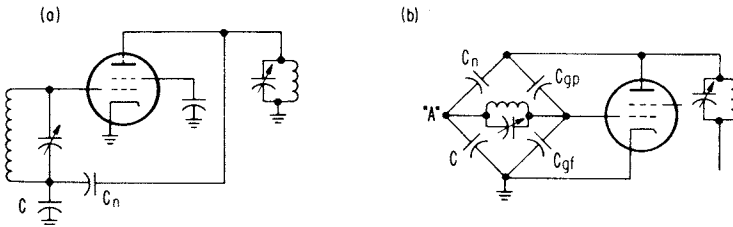

Figure 59. Single-ended grid neutralization described by Bruene, basic circuit.

capacitor, C_n , is considerably larger than the grid-to-plate capacitor and is about the size of those used for neutralizing triodes.

The basic circuit of this neutralization scheme is shown in Figure 59a. It can be redrawn as a capacitance bridge showing clearly the grid neutralization circuit (see Figure 59b). Balance is obtained when

$$\frac{C_n}{C} = \frac{C_{gp}}{C_{gf}}$$

where C_{gp} is the feedback capacitance grid-to-plate of the tetrode or pentode, the C_{gf} is the total input capacitance, including tube and stray capacitance.

A single-ended amplifier can also be neutralized by taking the plate circuit a small amount off ground as was done in the single-ended grid neutralizing scheme, and by using the tube capacitances as part of the bridge circuit (see Figure 60).

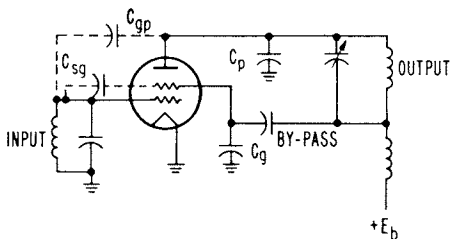

Figure 60. Single-ended plate neutralization, basic circuit.

This circuit differs from the usual r-f amplifier circuit in that the plate by-pass capacitor is returned to the screen side of the screen by-pass capacitor, C_s , and in adding stray capacitance from plate to ground, C_p . The size of screen by-pass capacitor, C_s , and the amount of stray capacitances in C_p are chosen to balance out the voltages induced in the input by the internal tube capacitances plate-to-grid, C_{gp} , and screen to grid, C_{sg} .

The circuit is redrawn in Figure 61 in the usual bridge form. Balance is obtained when

$$\frac{C_p}{C_s} = \frac{C_{gp}}{C_{sg}}$$

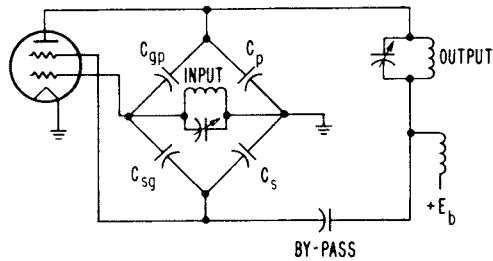

Figure 61. Single-ended plate neutralization showing capacitance bridge circuit present.

In usual tetrode and pentode structures the capacitance from screen-to-grid is roughly half the published tube input capacitance. The tube input capacitance is mainly the sum of the capacitance of the grid-to-screen and the capacitance grid-to-cathode. At first guess these two capacitances are roughly equal, so one is not far off in using half the listed tube input capacitance.

Note that in all neutralizing capacitance bridge circuits, it is assumed that the frequency is low enough so that inductances in the connecting leads and tube structures can be neglected. This is usually not the case in the VHF region, especially in single-ended tetrode and pentode stages where bridge circuits balance with a very small voltage in part of the bridge circuit. At VHF the small amount of voltage developed in the residual inductance of the screen circuit can be enough to accomplish neutralization in itself.

5.4 NEUTRALIZING GROUNDED-GRID AMPLIFIERS

Grounded-grid triode amplifiers offer an attractive alternative to the more usual grid-driven amplifier. The control grid is operated at r-f ground and serves as a shield to capacitive currents from the output to the input circuit. Generally, neutralization is not required until the control grid lead inductive reactance becomes significant. The feedback from the output to the input circuit is no longer due only to the plate-to-filament capacitance. The physical size of the tube and the operating frequency will determine when neutralization is required.

Two methods of neutralization are commonly used with grounded grid amplifiers. In the first method, the grids of a push-pull amplifier are connected to a point having zero impedance to ground, and a bridge of neutralizing capacitances is used which is equal to the plate-filament capacitances of the tubes.

The second method of neutralization requires an inductance between the grid and ground or between the grids of a push-pull amplifier of a value that will compensate for the coupling between input and output circuits resulting from the internal capacitances of the tubes.

Behavior of these two circuits are quite different. They may be considered as special forms of the more general case in which the neutralizing capacitors have values differing from the internal capacitances of the tubes, and in which an appropriate reactance is connected between the grids.

Under these conditions, the value of neutralizing capacitance permits continuous variation of the power amplification, stability, and negative feedback.

The purpose of neutralization is to make the input and output circuits independent of each other with respect to reactive currents. The input current must be independent of the output voltage, and reciprocally. This condition is necessary to permit independent tuning of the input and output circuits, so that the variations in output voltage do not produce variations of phase angle of the input impedance, resulting in phase modulation.

This condition of independence between input and output circuits, which may be called the "neutralized condition," does not necessarily imply stability. This is because the suppression of coupling by capacitive currents between input and output circuits is not sufficient to remove the effect of the output voltage on the cathode-to-grid voltage. A second condition, distinct from neutralization, must be met for complete stability. The effect of the control grid lead inductance must be cancelled.

5.4.1 Symmetrical Grid-Driven Amplifiers

A symmetrical or push-pull grid excited amplifier with grounded cathode is shown in Figure 62. If the inductance of the leads is considered to be negligible at the operating frequency, independence between the input and output circuits is generally obtained by cross-connecting the grids and plates through capacitors C_n having values equal to the internal grid-plate capacitance, C_{gp} , of the vacuum tubes. The requirements of stability and neutralization are fulfilled simultaneously because the input circuit is connected between the grids (in the case of a symmetrical stage) or between the cathode and grid (in a single-ended amplifier).

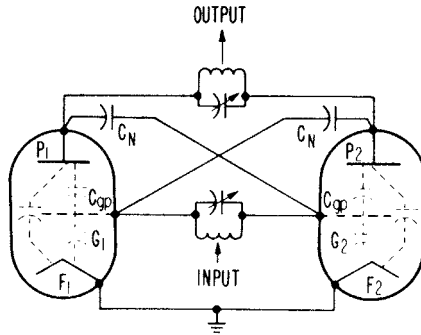

Figure 62. Neutralization of a symmetrical grid-excited amplifier by cross-connected capacitors.

5.4.2 Symmetrical Cathode-Driven Amplifiers

The same method of neutralization may be applied in symmetrical cathode-driven amplifiers where the grids are grounded and the lead inductances are considered to be negligible at the operating frequency. The grids and cathodes are inverted and the neutralizing capacitors, C_N , have a value equal to the internal cathode-plate capacitance, C_{fp} , of the vacuum tubes as shown in Figure 63.

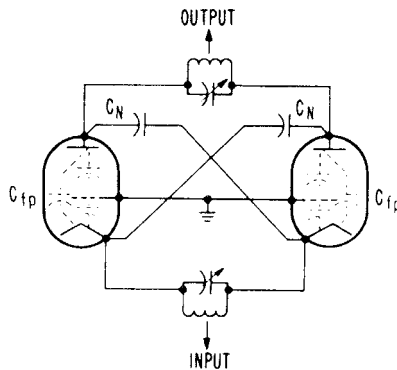

Figure 63. Neutralization by cross-connected capacitors of a symmetrical cathode-excited amplifier with grounded grids.

If the grids are not at ground potential because the inductance of the leads is not negligible, coupling may exist between the input and output circuits through the plate-grid capacitances, cathode-grid capacitances, and grid-to-grid inductance. One method of reducing this coupling is to insert between the grids, a series tuned circuit which has zero reactance at the operating frequency as shown in Figure 64.

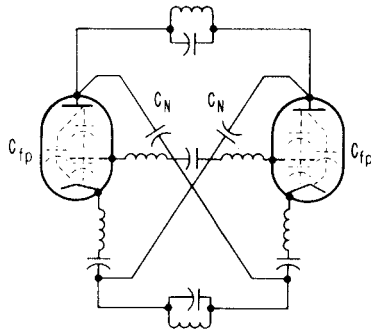

Figure 64. Neutralization by cross-connected capacitors of a symmetrical cathode-excited amplifier with compensation of lead inductance.

The neutralization scheme just described is useful only for the case where no grid current flows. If grid current flows, a grid resistance will appear in parallel with the grid-to-filament capacitance. If the resistance is small in comparison to the reactance of this grid-to-filament capacitance, phase modulation will be produced.

Another important property of the preceding neutralizing method is that power amplification is a function of the neutralizing capacitance while the independence of cathode and plate circuits from the viewpoint of reactive currents may be obtained with any value of neutralizing capacitance. If the neutralizing capacitance is less than the plate-to-filament capacitance of the tube, the stage will operate with low excitation power and high power amplification.

If the neutralizing capacitance is greater than the plate-to-filament capacitance, the power amplification would be quite low, but the total output power possible would be increased. A more complete discussion of grounded grid amplifier neutralization can be found in the references.^{13 14}

13 "The Inverted Amplifier," C. E. Strong, *Elect. Comm.*, V. 19, No. 3, 1941.

14 "Cathode Excited Linear Amplifiers," J. J. Muller, *Elect. Comm.*, V. 23, 1946.

5.4.3 Grounded-Grid Amplifiers with Grid Impedance

In the special case for the grounded-grid amplifier having a grid impedance and the reactive currents neutralized, the following equations and Figure 65 apply.

$$C_n = C_{fp} - \frac{C_{fg}}{\mu}$$

$$Z_g = - \frac{1}{[j\omega C_{fg} + C_{gp} (1 + \mu)]}$$

If in solving the equation for C_n the sign is negative, this indicates in-phase neutralization is required. Conversely, if the sign of C_n is positive, then out-of-phase neutralization is required.

A negative value of Z_g indicates capacitive reactance required and a positive value requires an inductive reactance to be used.

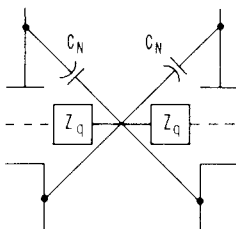

Figure 65. Circuit of grounded-grid amplifier having grid impedance and neutralized for reactive currents.

5.5 NEUTRALIZATION PROCEDURE

5.5.1 Breaking D-C Current Path

The first step to roughly adjust the neutralization is to break the d-c connections of the plate voltage and screen voltage leaving the r-f circuits intact. If the d-c current path is not broken, some current can flow in either one of these circuits even though the voltages are zero. The presence of this current causes the amplifier to work in the normal manner, generating r-f power in the plate circuit. It will then be incorrect to adjust for zero power in the plate circuit. Sufficient r-f grid drive must be applied to provide some grid current or to cause a sensitive r-f meter coupled to the plate to give an

indication of feed through power. When the plate circuit is tuned through resonance, the grid current will dip when the circuit is out of neutralization or the r-f meter will peak. The neutralization adjustments are made until the indication is minimum.

5.5.2 Feeding the Grid Circuit

Another very powerful tool for roughly neutralizing the amplifier is to feed the output from a signal generator into the grid circuit. A sensitive r-f detector is inserted between the output connector and the load. The neutralization can then be adjusted for minimum feed through. This technique is very useful in working with the prototype equipment. Actual quantitative measurements can be made. If the insertion loss of the amplifier is less than the expected gain, oscillation will occur. Circuit modification can be made until the isolation is sufficient to warrant a test with high voltages applied. The advantages of this "cold" system: (a) no components are subjected to unusual stress if the amplifier is unstable, and (b) safer, more convenient circuit modifications may be made.

5.5.3 Final Trimming

For the final trimming of the neutralization adjustment, the stage should be returned to operating condition at reduced power similar to that used when testing for parasitic oscillations, or under the final loaded operating conditions. At the higher frequencies and in the VHF region, it will be found that a small additional trimming adjustment of the neutralizing circuit is usually required. When the plate circuit is tuned through resonance, the minimum plate current and maximum control grid current should occur simultaneously. In the case of the tetrode and pentode the d-c screen current should be maximum at the same time.

The neutralizing procedures indicated above apply not only to the HF radio frequencies, but also apply in the VHF or UHF regions. In the latter cases the neutralizing circuit is different and the conventional cross-neutralization schemes may not apply.

As the radio frequency is increased, the reactance of the screen lead inductance of a tetrode or pentode no longer is negligible.

5.5.4 Feedback Circuits in Tetrodes and Pentodes

Careful analysis of the feedback circuits of tetrodes in the VHF region has been made and the basic concepts follow.

The same analysis applies to a pentode. In Figure 66 the tetrode circuit elements involved in the feedback circuits are indicated. These circuit elements are inherent and involve the residual capacitance plate-to-grid, the capacitance from plate-to-screen, the capacitance from screen-to-grid, and the inductance of the screen lead to the tube. It will be noted that the r-f voltage developed in the plate circuit E_p causes a current, I , to flow through the plate-to-screen capacitance, C_{ps} , and the inductance, L , in the screen leads. The passage of this current through the inductance L develops a voltage $-E$ which has a polarity opposite to that of the plate voltage, E_p .

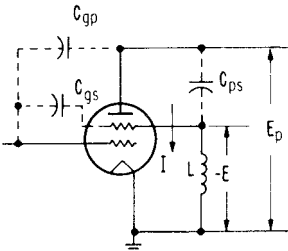

Figure 66. Tetrode characteristics involved in feedback circuit.

In Figure 67 the same circuit elements and voltages have been arranged with a graphical representation where the height above or below the zero line represents magnitude and polarity of the r-f voltage of that part of the circuit with respect to zero. Because all of the circuit components involved are pure reactances, the voltages are either in phase or out of phase, and so can be represented as positive and negative with respect to each other. The voltages plotted are the components only of the r-f output circuit voltage, E_p , and no

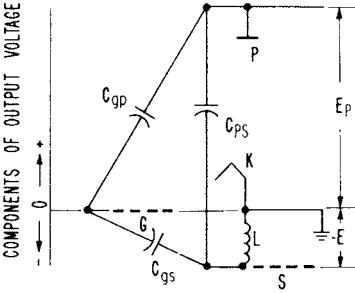

Figure 67. Graphical presentation of components of output circuit voltages in tetrode when self neutralized.

attempt is made to show the normal driving voltage on the grid. The plate "P" is shown at a high positive potential above zero and the magnitude is represented by the distance above the zero line as shown by the dimension, E_p . The voltage developed in the screen lead inductance places the screen at a negative voltage with respect to the plate voltage. The screen of the tube, S, is shown to be below the filament line, or negative, by the amount $-E$. If the circuit were perfectly neutralized, the control grid, G, would lie on the zero potential line or a filament potential insofar as any action of the r-f plate voltage, E_p , on the input circuit is concerned. If there is no component of output voltage developed between grid and filament, the circuit is neutralized.

The total r-f voltage between plate and screen comprises plate voltage and screen lead inductance voltage $-E$. This total voltage is applied across a potential divider consisting of the capacitance plate-to-grid, G_{pg} , in series with the capacitance grid-to-screen, C_{gs} . When this potential divider is suitably matched to the magnitudes of the voltage, E_p , and screen lead voltage, $-E$, the control grid will have no voltage difference to filament as a result of the output circuit voltage, E_p .

5.6 SELF-NEUTRALIZING FREQUENCIES OF TETRODES AND PENTODES

It should be noted in Figure 67 that the potential dividing action between capacitances plate-to-grid, C_{pg} , and grid-to-screen, C_{gs} , will not be affected by the operating frequency. It should also be noted that the division of voltage between plate and screen and screen and ground due to the charging current, I , will vary greatly with frequency. There will, therefore, be some particular frequency at which this potential dividing circuit places the grid at filament potential as far as the plate circuit action is concerned, and this is called the **self-neutralizing frequency** of the tetrode. At this particular frequency the tetrode, or pentode, is inherently neutralized due to the circuit elements within the tube structure and any external added screen lead inductance to ground. Typical self-neutralizing frequencies with normal screen by-passing are as follows:

APPROXIMATE SELF-NEUTRALIZING FREQUENCIES OF SOME EIMAC TETRODES AND PENTODES

TUBE TYPE	SOCKET	FREQUENCY (MHz)
4-1000A		25 - 30
4-400A		45 - 50
4-250A	(SEE NOTE)	45 - 50
4X500F		75 - 90
4-125A		75 - 90
4-65A		80 - 120
4X150A	SK-600	535 - 540
4CX250B	SK-600	545 - 555
4CX250R	SK-600	565 - 570
4CX350A	SK-600	460 - 470
4CX1000K	SK-820	385 - 395
4CX1000A	SK-810	380 - 390
4CX1500B	SK-810	380 - 390
4CX3000A	SK-1400A	125 - 130
4CX5000A	SK-300A	140 - 170
4CX15,000A	SK-300A	120 - 150
5CX1500A	SK-840	115 - 120
5CX1500A	SK-840*	190 - 300

*Air holes screened.

Note: Sockets are not called out for these tubes because the recommended sockets do not contain integral bypass capacitors. In these cases, bypass consideration depends on the individual circuit designer.

5.6.1 Operation Below Self-Neutralizing Frequency

When the tube is operated below the self-neutralizing frequency, the normal cross-neutralization circuits apply in this case, a neutralizing capacitor approximately equal to the plate-to-grid capacitance of the tube brings voltage of opposite polarity from the output circuit to the grid, or from the input circuit to the plate.

5.6.2 Operation Above Self-Neutralizing Frequency

If the operating frequency is higher than of the self-neutralizing frequency of the tetrode or pentode, the voltage, -E, developed in the screen lead inductance is too large to give the proper voltage

division between the internal capacitances of the tube. One obvious method of reducing the voltage in the screen lead reactance is to adjust the inductive reactance of the screen lead to ground so as to lower the total reactance. This takes the form of a series variable capacitor as shown in the graphical representation in Figure 65.

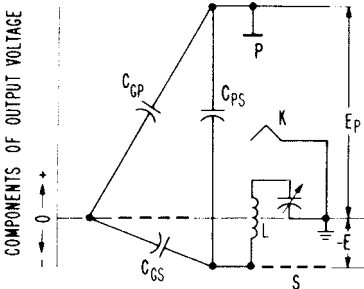

Figure 68. Components of output voltage of a tetrode when neutralized by added series screenlead capacitance.

Another method would be to change the potential divider network made up of the tube capacitance. This could be done by adding capacitance external to the tube between grid and plate. The method is shown in Figure 68A. This added capacitance plate-to-grid is on the same order of size as the residual grid-to-plate capacitance of the tube and, hence, is similar in construction to the neutralizing capacitance used at a lower frequency. However, in this case, the small wire or rod standing up beside the tube “looking” at the plate (and so forming a neutralizing capacitor) is connected to the grid of the tube rather than to an opposite polarity in the input circuit.

If the r-f power amplifier is operating above the self-neutralizing frequency of the tube and must be tuned over a range of frequencies, it is probably easier to use the screen series tuning capacitor method and make this control available to the operator. If operation is desired over a range of frequencies including the self-neutralizing frequency of the tube, this circuit is also desirable because the incidental lead inductance in the variable tuning capacitor lowers the self-neutralizing frequency of the circuit so that the neutralizing series capacitor can be made to operate over the total desired frequency range. Obviously, if the range is too great, switching of neutralizing circuits will be required. A small 50 to 100 pF variable capacitor in the screen lead has been found to be satisfactory.

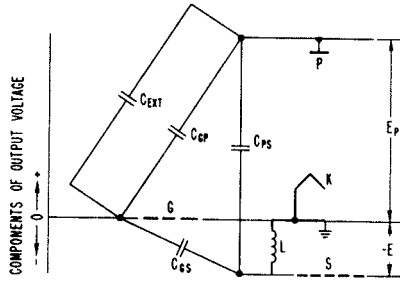

Figure 68A. Components of output voltage of a tetrode when neutralized by added external grid-to-plate capacitance.

Another method of changing the self-neutralizing frequency of a tetrode or pentode is obtained when using the general by-passing arrangement of the screen and the filament shown in Figure 69. The screen lead by-passed with minimum inductance to the filament terminal of the tube. Some inductance is introduced in the common filament and screen grounding lead.

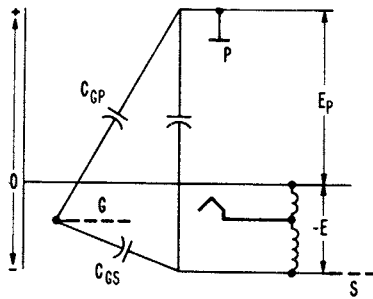

Figure 69. Components of output voltage of a tetrode neutralized by adding inductance common to screen and cathode return.

The grid is shown below the zero voltage or chassis potential, indicating that the voltage developed in the total screen lead inductance to chassis is excessive. If now the filament is tapped up on this inductance, a point can be found where the voltage difference between grid and filament is zero as far as the

components of plate voltage are concerned. The arrangement will be found to self-neutralize at a higher frequency than if the filament and screen were separately by-passed to the chassis. Thus, by increasing the self-neutralizing frequency of the tube and screen by-pass arrangement, the tendency of the VHF parasitic to occur is reduced.

If now the frequency of the VHF parasitic is reduced by increasing the inductance of the plate lead (presuming this is the principle frequency defining circuit), it can be made to approach the self-neutralizing frequency of the tube and so suppress the parasitic.